

BATHROOM

IDEAL BAGNI

**DISCOVERING
LAUNDRY
COLLECTION
2023**



IDEALBAGNI

BATHROOM

IDEAL BAGNI

LAUNDRY COLLECTION



IT Progettare con attenzione il bagno significa creare un ambiente tutto per sé e per la cura del proprio corpo. La scelta delle finiture e dei colori, la tipologia di arredi, la disposizione dei moduli, la scelta dei dettagli: qualunque sia la dimensione dello spazio è possibile realizzare una stanza personalizzata nello stile e nella praticità. Grazie alla qualità, alla modularità, alle lavorazioni su misura e alla sartorialità di Ideal Bagni, l'ambiente bagno è proprio come lo hai sempre desiderato.

EN Furnishing and decorating a bathroom means blending together functional and aesthetic features. Today Ideal Bagni bathroom vanities, units, tops come in all sorts of shapes and sizes, colours and finishes: whatever the space available is, a custom-made bathroom can be designed as per your own style and wish thanks to our quality, wide range of elements and tailor-made solutions.

FR Créer une salle de bain veut dire mélanger les détails fonctionnels et esthétiques pour réaliser un espace où on prend soin de son corps. Aujourd'hui Ideal Bagni offre les éléments sous-lavabos, les éléments muraux et les plans dans une vaste gamme de formes, dimensions, coloris et finitions : quel que soit l'espace disponible, une salle de bain sur mesure peut être réalisée selon son propre goût et souhait grâce à la qualité, la gamme large des articles et les solutions sur mesure.

-- Company profile

Ideal Bagni è una realtà dinamica e in continua evoluzione nel settore dell'arredobagno, rinnovata nelle tecnologie, nel design e nelle collezioni. Nuove logiche produttive, tante possibilità di personalizzazione e un'ampia gamma di finiture sono gli elementi chiave di un'azienda al passo con i tempi, capace di rispondere a tutte le esigenze.

^{EN} Ideal Bagni is a dynamic company which carries on a no-stop research in the bathroom furnishing field. It has recently renewed the production technologies, the design and most of the collections, allowing the company to reply to any requirement thanks to its brand-new proposal and extensive range of colour and material combinations.

^{FR} Ideal Bagni est une société dynamique toujours en évolution. Elle s'est renouvelée au niveau de la technologie, de la production et de son design en présentant des nouvelles collections dans une vaste gamme des finitions qui permet de répondre à toutes les exigences.

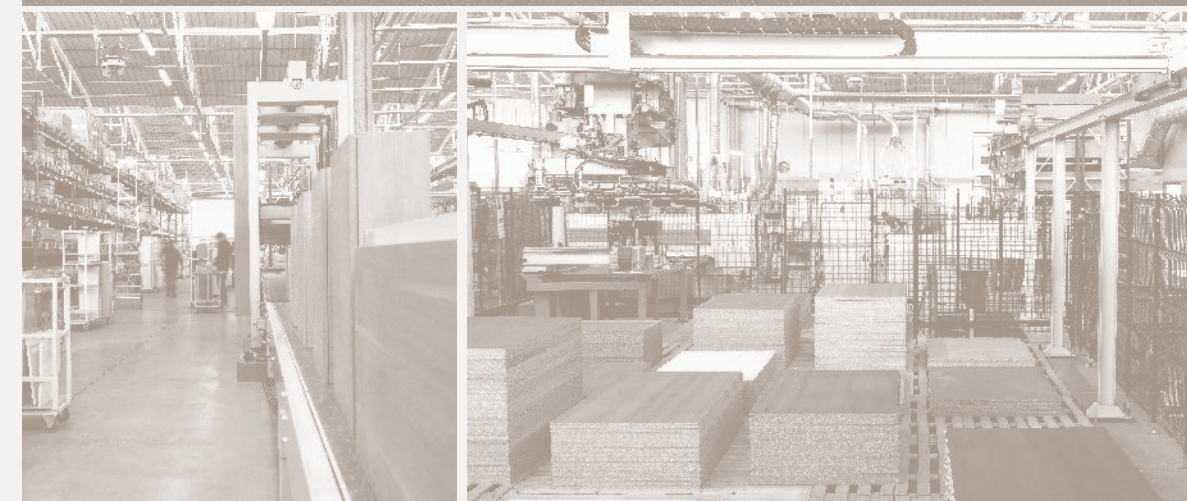

**La nuova lavanderia
Ideal Bagni amplia
la modularità,
propone inedite
finiture, aggiunge
originali elementi
di design per
realizzare progetti
d'arredo innovativi
e di tendenza.**

The new Ideal Bagni laundry collection offers greater modularity, unique finishes and original design features, for innovative and on-trend interiors.

La nouvelle buanderie Ideal Bagni amplifie la modularité, propose des finitions inédites, ajoute des éléments de design originaux pour réaliser des projets d'ameublement innovants et de tendance.



Indice

Index · Index

- 010** · Composizioni
compositions
compositions
- 140** · Accessori metallici
metal accessories
accessoires métalliques
- 144** · Finiture frontali
front-panel finishes
finitions façades
- 146** · Finiture top
top finishes
finitions du plan de toilette
- 148** · Riepilogo composizioni
overview of compositions
récapitulatif des compositions

Laundry

Ideal Bagni

**Da stanza di servizio
a vero e proprio
ambiente da arredare
con stile e funzionalità:
ogni lavanderia
Ideal Bagni è un progetto
che si adatta a tutti
gli spazi e le esigenze.**

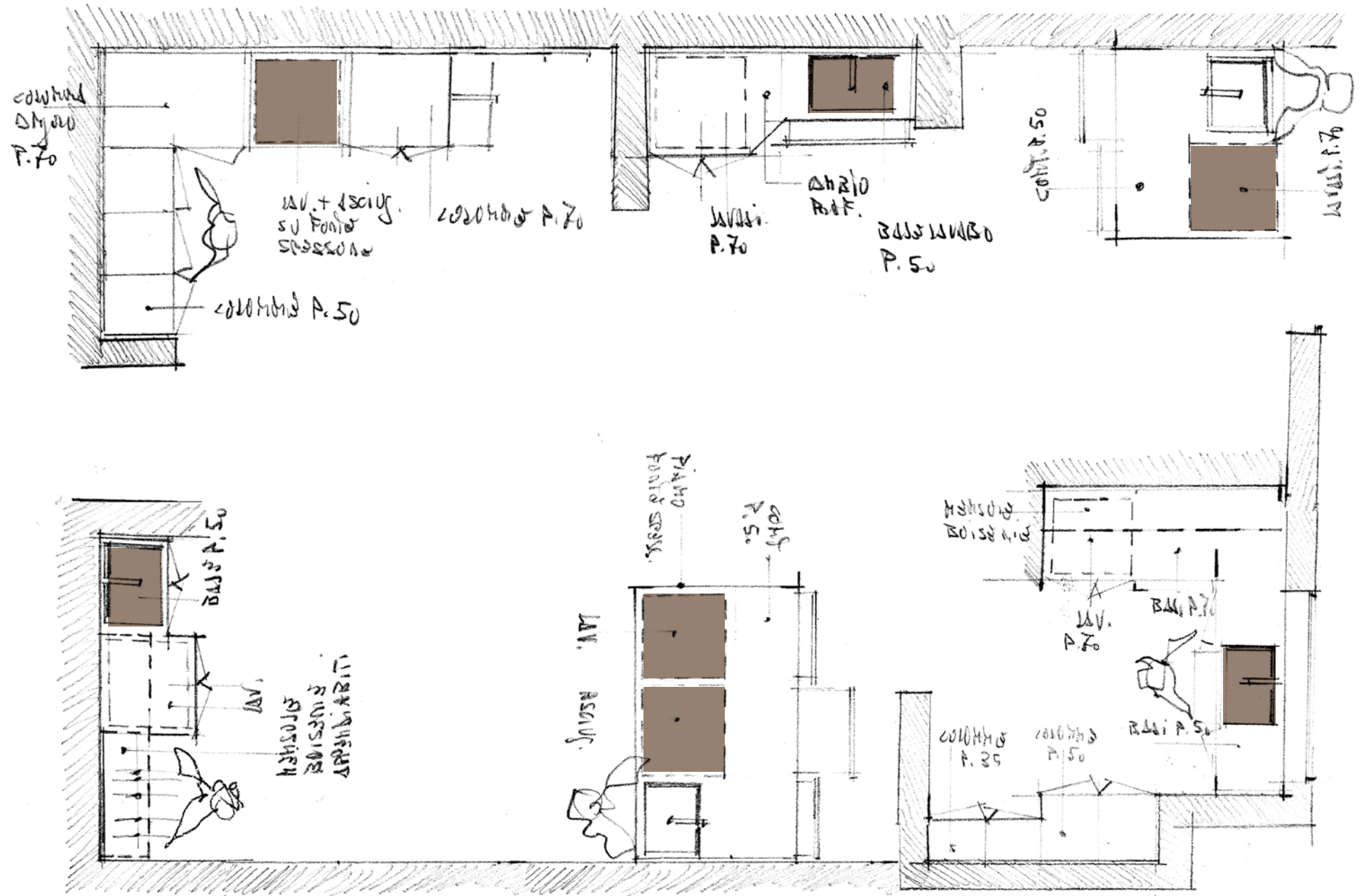

From simple utility space to a room to furnish with style and functionality: every Ideal Bagni laundry area is a flexible project that can be adapted to any space and requirements.

De pièce de service à véritable espace à meubler avec style et fonctionnalité, chaque buanderie Ideal Bagni est un projet qui s'adapte à tous les espaces et les besoins.



Ideal Laundry

Insieme alle colonne, le basi H 75 cm con piedini in Frassino Naturale offrono un grande contenimento e, allo stesso tempo, sono anche un comodo ed ergonomico piano di appoggio e di lavoro.

Together with tall units, the H. 75 cm base units with feet in Frassino Naturale offer ample storage and also provide a comfortable and ergonomic work surface.

Avec les colonnes, les éléments bas H 75 cm avec pieds en Frassino Naturale offrent un grand rangement et sont également un pratique et ergonomique plan d'appui et de travail.



Ideal Laundry

Comp. 601

01 Basi + tavolo / bases + table / bases + table
l. 180/190 x h. 87.5 x p. 50 cm

02 Colonne / columns / colonnes
l. 253 x h. 200 x p. 70 cm

03 Basi / base units / éléments bas
l. 270 x h. 85 x p. 50 cm

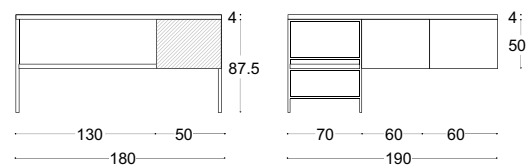

01

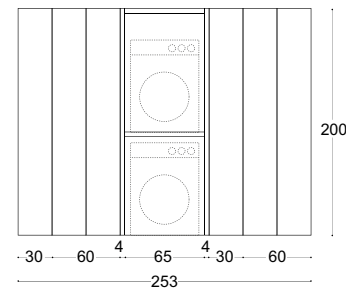

02

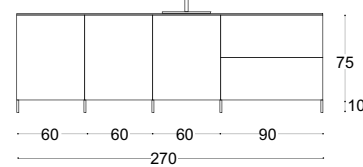

03

PENISOLA OPERATIVA

La lavanderia è un concentrato di funzionalità: moduli contenitori a terra e sospesi, una zona lavaggio con tavoletta, un'area stiro realizzata con gambe in metallo verniciato e piani spessore 4 cm, un pratico appendiabiti a parete e vani a giorno per la lavatrice e l'asciugatrice.

Melaminici / melamine / mélaminés



Frassino naturale

Ghiaccio

• WORK ISLAND

The laundry area is the epitome of functionality: modular containers at ground level and raised, a washing area with washboard, an ironing area created with coated metal legs and 4 cm thick tops, a practical clothes rail on the wall and open units to hold washing machine and dryer.

• ÎLOT OPÉRATIONNEL

La buanderie est un concentré de fonctionnalité : modules de rangement au sol ou suspendus, zone de lavage avec tablette, zone de repassage réalisée avec pieds en métal peint et plan de 4 cm d'épaisseur, pratiques patères murales et niches ouvertes pour le lave-linge et le sèche-linge.



**Una soluzione compatta
e funzionale in cui c'è
tutto quello che serve.**



A compact and functional solution containing everything needed for a perfectly organised laundry area.

Une solution compacte et fonctionnelle où il y a tout ce qu'il faut pour organiser une buanderie parfaite.



Ideal Laundry

Comp. 602

01 Colonne / columns / colonnes
l. 240 x h. 200 x p. 50 cm

02 Basi + tavolo / bases + table / bases + table
l. 204 x h. 200 x p. 70 cm

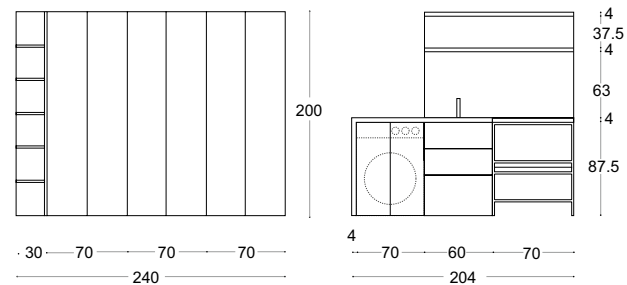

01

02



TERMINALE A GIORNO

Se l'armadiatura è disposta verso l'ingresso o una zona di passaggio, il terminale a giorno diventa decorativo oltre che funzionale.

La finitura Noce Canaletto richiama quella della boiserie e le venature si abbinano alla matericità del top in Piasentina.

Melaminici + laccato / melamine + lacquer / mélaminés + Laqué

Noce
Canaletto

Piasentina

Tamigi

020

• OPEN END UNIT

If cupboards are positioned facing an entrance or walkway, the open end unit takes on a decorative role in addition to its functional purpose. The Noce Canaletto finish complements the wood panelling, and the grain matches the material finish of the Piasentina top.

• TERMINAL OUVERT

Si l'armoire est disposée vers l'entrée ou une zone de passage, le terminal ouvert devient décoratif en plus de fonctionnel. La finition Noce Canaletto rappelle celle du revêtement mural et les veinures s'associent à la matière du plan de toilette en Piasentina.



021



Ideal Laundry

Comp. 603

Composizione / composition / composition
l. 290 x h. 200 x p. 35/70.5 cm

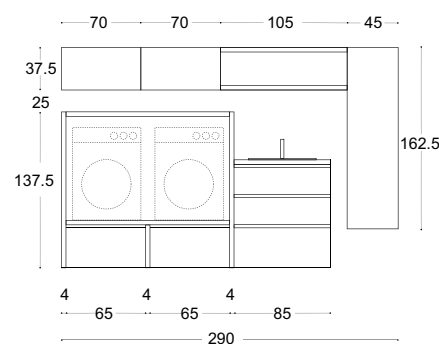
**MAXI LAVABO**

La soluzione compositiva ideale per chi vuole creare una zona operativa molto funzionale: il maxi lavabo in ceramica L 70 cm è l'ideale per il lavaggio a mano ed è affiancato ai vani a giorno dal forte spessore che contengono lavatrice e asciugatrice.

Melaminici / melamine / mélaminés



Rovere
Nodato

Vulcano

• **MAXI WASHBASIN**

The ideal composition solution for those who want to create a highly functional utility area. The ceramic maxi washbasin, L. 70 cm, is ideal for handwashing and combines with thick open day units containing washing machine and dryer.

• **MAXI LAVABO**

La solution de composition idéale pour ceux qui souhaitent créer une zone opérationnelle très fonctionnelle : le maxi lavabo en céramique L 70 cm est parfait pour le lavage à la main et il est juxtaposé à des niches ouvertes de forte épaisseur contenant lave-linge et sèche-linge.

Ideal Laundry

ALTEZZA ERGONOMICA

Anche in una lavanderia i dettagli possono fare la differenza: gli elettrodomestici sono sollevati da terra per un utilizzo ergonomico, i cassettoni estraibili sono comodi per riporre i detersivi e la luce a led sottopensile illumina in modo diffuso il piano di lavoro.



• ERGONOMIC HEIGHT

Even in a laundry area, details can make all the difference: appliances are raised off the ground for ergonomic use, removable deep drawers provide handy storage for cleaning products and LED strip lights under wall units illuminate the work surface.

• HAUTEUR ERGONOMIQUE

Même dans une buanderie les détails peuvent faire la différence : les électroménagers sont soulevés du sol pour une utilisation ergonomique, les grands tiroirs extractibles sont pratiques pour ranger les détergents et l'éclairage à led sous-haut éclaire de manière diffuse le plan de travail.



Soluzioni compatte e moduli speciali arredano gli spazi ridotti mantenendo lo stile e la funzionalità.

Comp. 604

01 Colonne / columns / colonnes
l. 142 x h. 200 x p. 50 cm

02 Basi / base units / éléments bas
l. 163 x h. 137.5 x p. 70.5 cm

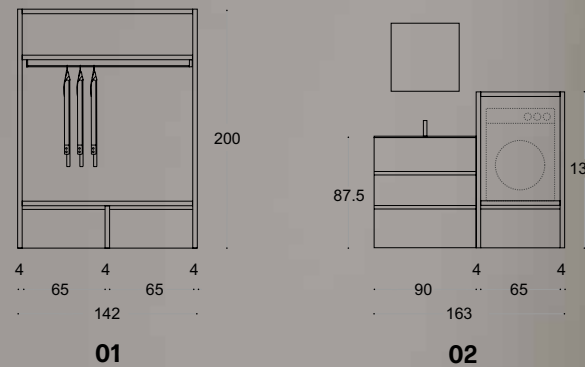

Laccato + melaminico / lacquer + melamine / laqué + mélaminé



Bosco

Rovere Nodato

Special compact and modular solutions to decorate tight spaces while maintaining style and functionality.

Des solutions compactes et des modules spéciaux meublent les espaces réduits en maintenant le style et la fonctionnalité.







FORTE SPESSORE

Il top dal forte spessore in finitura Rasato Malta racchiude la base lavabo, la lavatrice e l'asciugatrice in una composizione lineare. I cassettoni hanno diverse altezze per contenere flaconi di detersivi, biancheria e tutto ciò che può essere utile.

• ROBUST THICKNESS

The thick top in Rasato Malta finish closes the washbasin base unit, washing machine and dryer in a linear composition. Deep drawers have varying heights to contain different cleaning products, laundry and everything of use.

• FORTE ÉPAISSEUR

Le plan de toilette de forte épaisseur Rasato Malta renferme l'élément bas pour lavabo, lave-linge et sèche-linge dans une composition linéaire. Les grands tiroirs ont différentes hauteurs pour ranger les détergents, le linge et tout ce qui peut être utile.



Ideal Laundry

Comp. 605

01 Colonne / columns / colonnes
l. 210 x h. 200 x p. 50 cm

02 Basi / base units / éléments bas
l. 224 x h. 87.5 x p. 35/70.5 cm

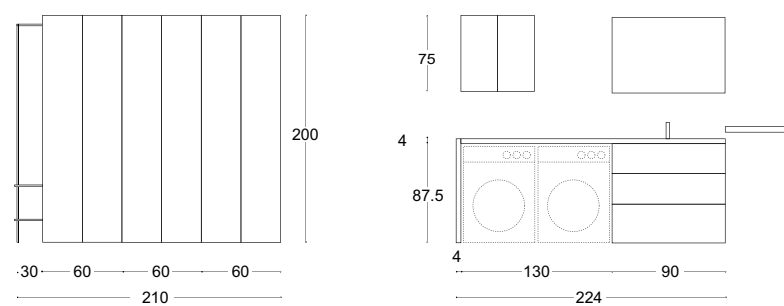

01

02

COLONNE ATTREZZATE

Organizzare lo spazio è fondamentale per sfruttarlo al meglio: l'armadiatura è attrezzata all'interno con ripiani e vani a giorno e all'esterno, sul fianco, con un appendiabiti in metallo verniciato. La lavanderia diventa anche un pratico guardaroba.

Melaminici + laccato / melamine + lacquer / mélaminés + laqué

Rasato
Malta

Ghiaccio

Fango

• FITTED TALL UNITS

Organising space is essential for optimal utility: cupboards are equipped with interior shelving and open units, as well as exterior side clothing rail in coated metal. The laundry room also becomes a handy wardrobe.

• COLONNES ÉQUIPÉES

Organiser l'espace est fondamental pour l'exploiter au mieux, l'armoire est équipée à l'intérieur avec des tablettes et des niches ouvertes et à l'extérieur, sur le côté, avec des patères en métal peint. La buanderie devient également une pratique penderie.





Comp.606

01 Colonne / columns / colonnes
l. 142 x h. 137.5 x p. 70.5 cm

02 Basi / base units / éléments bas
l. 120 x h. 87.5 x p. 35/50 cm

Misure / mesures / mesures

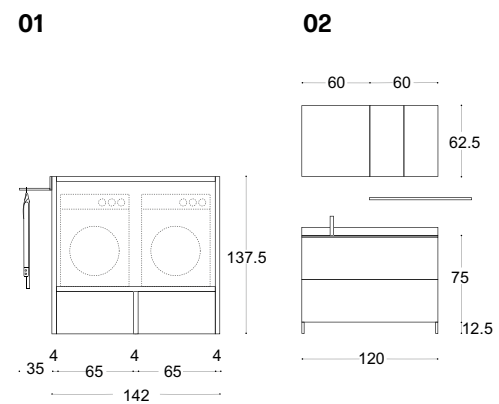

Melaminici / melamine / mélaminés

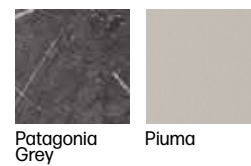

Comp.607

01 Basi / base units / éléments bas
l. 148 x h. 37.5 x p. 70.5 cm

02 Basi / base units / éléments bas
l. 130 x h. 162.5 x p. 35 cm

Misure / mesures / mesures

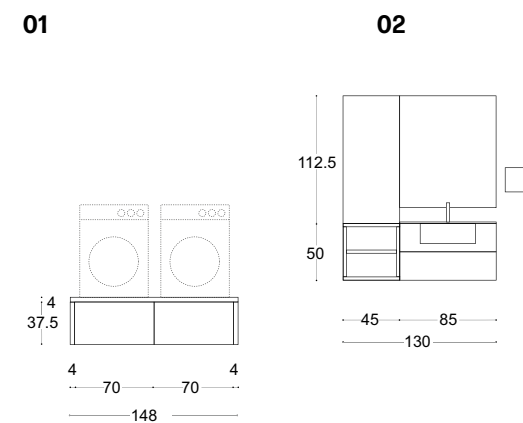

Melaminico + laccato / melamine + lacquer / mélaminé + laqué

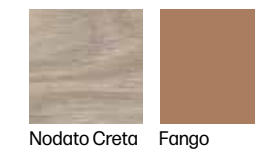



Ideal Laundry

Comp. 608

Composizione / composition / composition
l. 208 x h. 200 x p. 50,5 cm

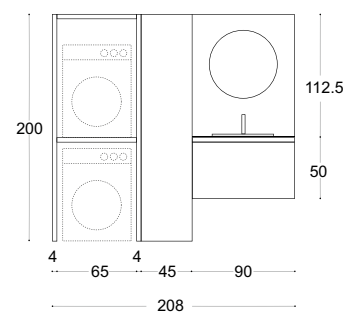

BOISERIE CON SPECCHIO

All'interno di una struttura dal forte spessore, lavatrice e asciugatrice sono disposte una sopra l'altra in modo da sfruttare lo spazio in altezza. La boiserie in Rovere Nodato è un elemento decorativo che rifinisce la lavanderia.

Laccato + melaminico / lacquer + melamine / laqué + mélaminé



Pistacchio

Rovere Nodato

• WOOD PANELLING WITH MIRROR

Washing machine and dryer are positioned one above the other in a thick structure, optimising use of vertical space. Wood panelling in Rovere Nodato finish features as a decorative element completing the laundry area.

• REVÊTEMENT MURAL AVEC MIROIR

À l'intérieur d'une structure de forte épaisseur, le lave-linge et le sèche-linge sont disposés l'un sur l'autre de manière à exploiter l'espace en hauteur. Le revêtement mural en Rovere Nodato est un élément décoratif qui finit la buanderie.



Ideal Laundry

Tutto in poco spazio: la consolle con lavabo integrato in Idealcryl L 120 cm è dotata di una tavoletta per il lavaggio a mano degli indumenti, mentre il cassettone e la colonna con ripiani interni offrono spazio per il contenimento.

Everything in a small space: the console with built-in washbasin in Idealcryl L. 120 cm is equipped with a washboard for hand washing clothes, while the deep drawer and tall unit with interior shelves offer storage space.

Tout en peu d'espace : la console avec lavabo intégré en Idealcryl L 120 cm est équipée d'une tablette pour le lavage à la main des vêtements, tandis que le grand tiroir et la colonne avec tablettes intérieures offrent de l'espace pour le rangement.



**Grande funzionalità
per piccoli spazi:
la lavanderia Ideal Bagni
è anche questo.**



Optimum functionality in small spaces: the new Ideal Bagni laundry range offers this too.

Grande funzionalità pour de petits espace : la nouvelle buanderie Ideal Bagni est aussi cela.



Ideal Laundry

Comp. 609

01 Basi / base units / éléments bas
l. 154 x h. 191.5 x p. 70.5 cm

02 Colonne / columns / colonnes
l. 226 x h. 200 x p. 50.5 cm

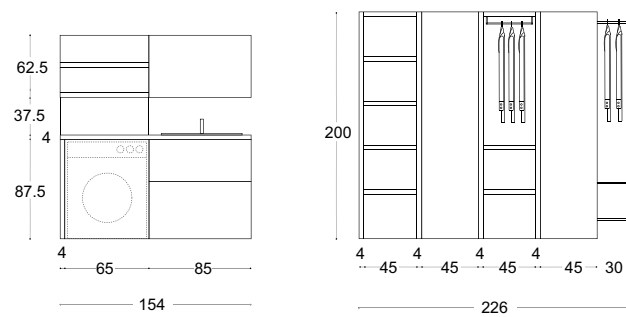

01

02

BOISERIE CON MENSOLE

Oltre al contenimento, in lavanderia è importante avere anche più punti d'appoggio: sopra la lavatrice e di fianco al lavabo, ad esempio, c'è una superficie libera. Anche la boiserie con mensole crea spazio da utilizzare per ciò che deve essere tenuto a portata di mano.

Melaminici / melamine / mélaminés

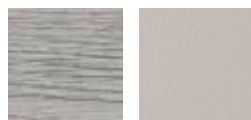

Rovere
Gessato

Piuma



- **WOOD PANELLING WITH SHELVES**

In addition to storage, in the laundry area it is important to also have plenty of surface space: above the washing machine and next to the washbasin, for example, there are free spaces. Wood panelling with shelves also creates space for everything that needs to be kept on hand.

- **REVÊTEMENT MURAL AVEC ÉTAGÈRES**

Oltre al rangement, dans une buanderie il est important d'avoir aussi plusieurs points d'appui : sur le lave-linge et sur le côté du lavabo, par exemple, il y a une surface libre. Le revêtement mural avec étagères crée également de l'espace à utiliser pour ce qui doit rester à portée de main.





Ideal Laundry

Comp. 610

01 Colonne / columns / colonnes
l. 113 x h. 200 x p. 50.5 cm

02 Basi / base units / éléments bas
l. 210 x h. 87.5 x p. 70.5 cm

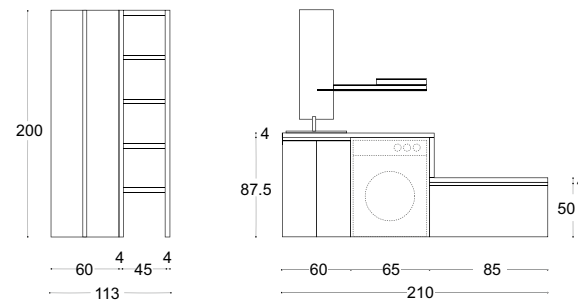

01

02

DOPPIA ALTEZZA

Una composizione caratterizzata da due altezze diverse: nella parte più alta, un piano e un fianco dal forte spessore creano un vano con ante e un vano porta lavatrice; nella parte più bassa, il piano diventa un utilissimo piano di appoggio con cassettoni.

Melaminico / melamine / mélaminé



Frassino
Bianco

050

• DOUBLE HEIGHT

A composition featuring two different heights: at the top there is a top and thick side element creating a compartment with doors and a washing-machine compartment. In the lower section, the top becomes a handy surface for placing items with a deep drawer.

• DOUBLE HAUTEUR

Une composition caractérisée par deux hauteurs différentes : dans la partie la plus haute, un plan et un côté de forte épaisseur créent une niche avec portes et une niche porte lave-linge ; dans la partie la plus basse, le plan devient un plan d'appui avec grand tiroir très utile.



051

Ideal Laundry

Grazie ai ripiani inclinati, la colonna diventa una pratica scarpiera. La maniglia Vela in metallo verniciato è integrata sul profilo dell'anta e ne consente un'agevole apertura.

With its sloping shelves, the tall unit offers practical shoe storage. The Vela handle in coated metal is integrated into the profile of the door and enables easy opening.

Grâce aux tablettes inclinées, la colonne devient un pratique meuble à chaussures. La poignée Vela en métal peint est intégrée sur le profil de la porte et en permet une ouverture facile.



Una composizione all'altezza delle aspettative e di ogni esigenza.

A composition that meets functional expectations and requirements.

Une composition à la hauteur des attentes et des besoins de fonctionnalité.

Comp. 611

Composizione / composition / composition
l. 227 x h. 200 x p. 35/70.5 cm

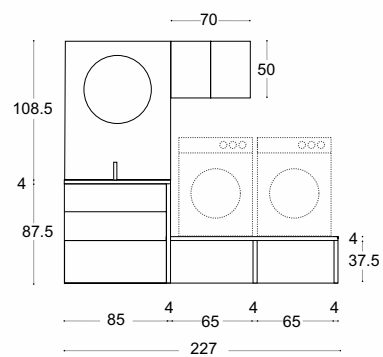

Laccati + melaminico / lacquers + melamine / laqué + mélaminé



Rosso India Rosa Quarzo Piasentina





Ideal Laundry

Comp. 612

01 Basi / base units / éléments bas
l. 234 x h. 87.5 x p. 70.5 cm

02 Basi / base units / éléments bas
l. 190 x h. 50 x p. 50

03 Colonne / columns / colonnes
l. 228 x h. 200 x p. 50 cm

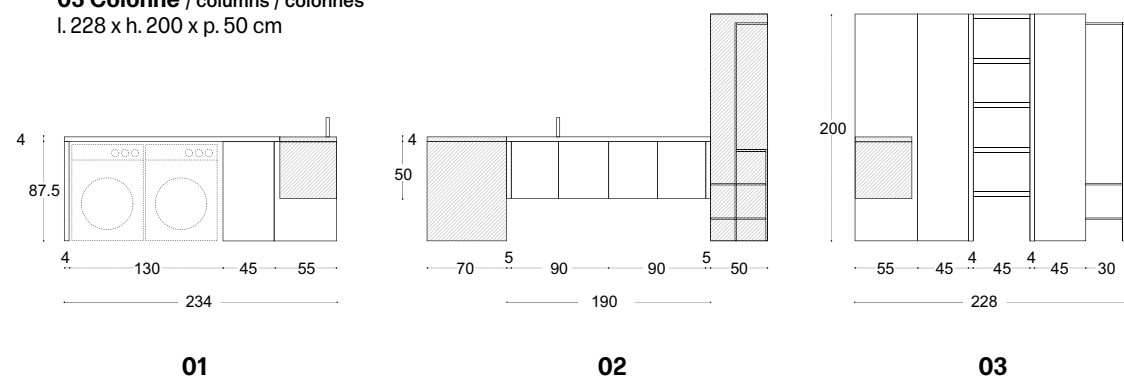

MODULI AD ANGOLO

Gli angoli sono spesso difficili da arredare, ma con la base e la colonna ad angolo ogni centimetro di spazio viene sfruttato al meglio. Così strutturata, la lavanderia è un ambiente completo di ogni funzionalità.

Melaminici / melamine / mélaminés



Rasato
Bianco

Tortora

• CORNER MODULES

Corners can be difficult to furnish, but with these base and tall corner units every centimetre of space is optimised. Utilising this structure, the laundry area is complete with all functional features.

• MODULES D'ANGLE

Les angles sont souvent difficiles à aménager, mais avec l'élément bas et la colonne d'angle chaque centimètre d'espace est exploité au mieux. Ainsi structurée, la buanderie est un espace pourvu de toute fonctionnalité.



Ideal Laundry

SOLUZIONI SALVASPAZIO

La base e la colonna ad angolo sono sia elementi di contenimento, sia di raccordo tra più lati della stanza. I vani interni sono tutti accessibili e permettono di non sprecare spazio bensì di ottimizzarlo.



• SPACE-SAVING SOLUTIONS

The base and tall corner units are useful both for storage and to connect the different sides of the room. Interior compartments are all accessible and ensure space is not wasted, but instead optimised.

• SOLUTIONS GAIN DE PLACE

L'élément bas et la colonne d'angle sont aussi bien des éléments de rangement, que de raccord entre plusieurs côtés de la pièce. Les niches intérieures sont toutes accessibles et permettent de ne pas gaspiller d'espace, mais au contraire de l'optimiser.





Comp.613

01 Basi / base units / éléments bas
l. 184 x h. 87.5 x p. 70 cm

02 Basi / base units / éléments bas
l. 255 x h. 37.5 x p. 35/50 cm

Misure / mesures / mesures

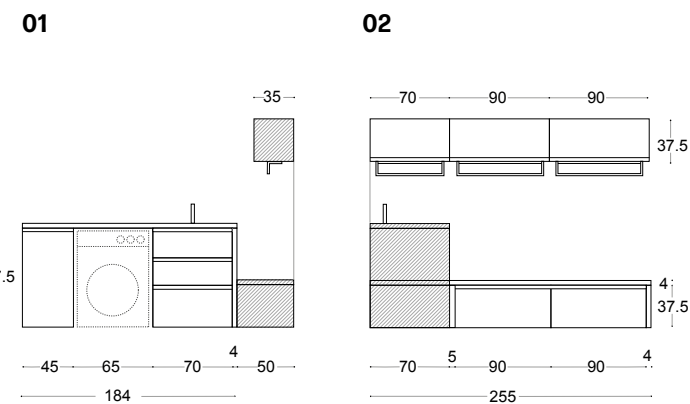

Melaminici / melamine / mélaminés

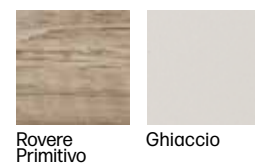

Comp.614

01 Basi / base units / éléments bas
l. 180 x h. 200 x p. 50 cm

02 Basi / base units / éléments bas
l. 135 x h. 87.5 x p. 70 cm

Misure / mesures / mesures

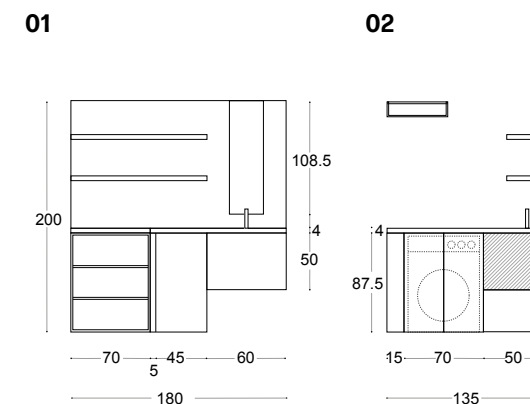

Melaminici / melamine / mélaminés





Ideal Laundry

La lavanderia è ricercata dal punto di vista estetico e compositivo. Si distingue infatti per l'abbinamento di moduli e finiture diverse: Patagonia Brown per le basi con cassetti e cassettoni, Noce Canaletto per i pensili in più altezze e per una colonna, vetro per due colonne.

The laundry area is refined in its aesthetics and composition. It is distinguished by the combination of different modules and finishes: Patagonia Brown is used for drawers and deep drawers, Noce Canaletto for multiple-height wall units and one tall unit, and glass for the other two wall units.

La buanderie est recherchée du point de vue esthétique et de la composition. Elle se distingue pour l'association de modules et de finitions différentes : Patagonia Brown pour les éléments bas avec tiroirs et grands tiroirs, Noce Canaletto pour les éléments hauts en différentes hauteurs et pour une colonne, verre pour deux colonnes.



Ideal Laundry

Comp. 615

Composizione / composition / composition
l. 345 x h. 250 x p. 35/50/70 cm

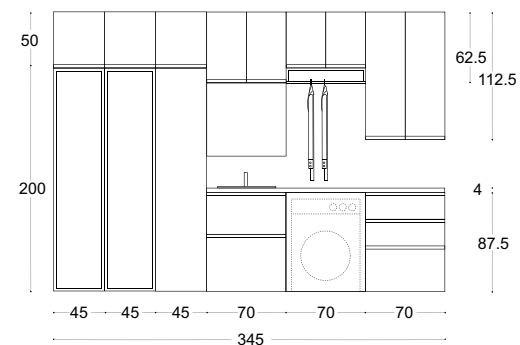

MANIGLIA VELA

Il profilo gola, orizzontale e verticale, caratterizza la modalità di apertura e l'estetica di cassetti, cassettoni, pensili e colonne. Un dettaglio di stile che può essere personalizzato e crea giochi di linee.

Melaminici / melamine / mélaminés



Noce
Canaletto

Patagonia
Brown

• VELA HANDLE

The groove handle profile, running both horizontally and vertically, defines the method of opening and the aesthetics of drawers, deep drawers, wall units and tall units. This style detail can be customised and creates interplay with different lines.

• POIGNÉE VELA

Le profil gorge, horizontal ou vertical, caractérise la modalité d'ouverture et l'esthétique de tiroirs, grands tiroirs, éléments hauts et colonnes. Un détail de style qui peut être personnalisé et crée des jeux de lignes.



Ideal Laundry

Sopra le colonne sono stati aggiunti dei pensili per sfruttare lo spazio in altezza. Le ante in vetro con telaio in metallo alleggeriscono visivamente la composizione, che è caratterizzata da una grande varietà di elementi.

Wall units have been added above the tall units to optimise use of vertical space. Glass doors with metal frame visually lighten the composition, which features a wide variety of different elements.

Sur les colonnes ont été ajoutés des éléments hauts pour exploiter l'espace en hauteur. Les portes vitrées avec cadre en métal allègent visuellement la composition, qui est caractérisée par une grande variété d'éléments.



Moduli sovracolonna e pensili sono perfette soluzioni salvaspazio per arredare le altezze.

Modules above tall units and wall units are the ideal space-saving solutions for vertical space.

Les modules sur-colonne et les éléments hauts sont de parfaites solutions gain de place pour meubler les hauteurs.

Comp. 616

Composizione / composition / composition
l. 199 x h. 250 x p. 35/70 cm

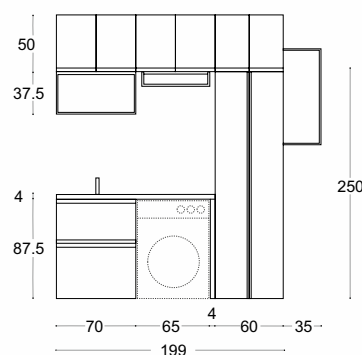

Melaminico + laccato / melamine + lacquer / mélaminé + laqué

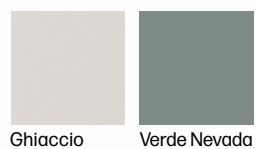



Ideal Laundry

Comp. 617

01 Colonne / columns / colonnes
l. 158 x h. 200 x p. 70.5 cm

02 Basi + colonne / base units + columns / éléments bas + colonnes
l. 255 x h. 87.5/200 x p. 35 cm

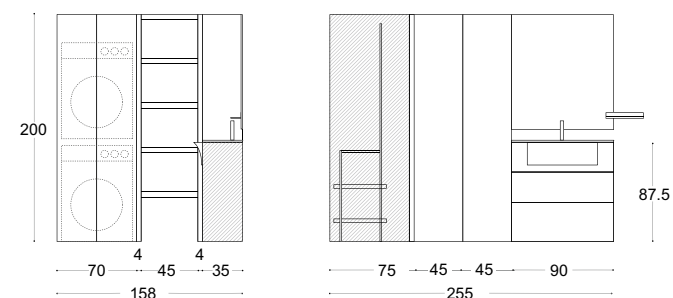

01

02

PROFONDITÀ RIDOTTA

Il lavabo a semincasso in Idealcryn è la soluzione ideale quando lo spazio è poco: il mobile ha profondità ridotta 35 cm, ma il lavabo sporge e resta di dimensioni comode. L'aggiunta della tavoletta facilita il lavaggio a mano.

Melaminici / melamine / mélaminés

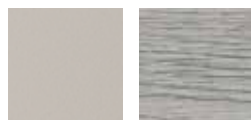

Piuma

Rovere
Gessato**• REDUCED DEPTH**

The semi-recessed washbasin in Idealcryn is an ideal solution when there is little space. This piece of furniture has a reduced depth of 35 cm, but the washbasin extends outwards and maintains practical dimensions. The addition of a washboard enables hand washing.

• PROFONDEUR RÉDUITE

Le lavabo semi-encasté en Idealcryn est la solution idéale lorsque l'espace est petit : le meuble a une profondeur réduite de 35 cm, mais le lavabo dépasse et reste avec de pratiques dimensions. L'ajout de la tablette facilite le lavage à la main.



Ideal Laundry

Le colonne ad angolo con profondità 35 cm, affiancate alla base, si uniscono alle colonne con profondità 70 cm per creare un'armadiatura molto funzionale che arreda entrambe le pareti dell'ambiente e ottimizza lo spazio a disposizione.

Corner tall units with a depth of 35 cm, combined with a base unit, are added to tall units with a depth of 70 cm to create highly functional cupboard space that features on both walls of the room and optimises that available area.

Les colonnes d'angle avec une profondeur de 35 cm, juxtaposées à l'élément bas, s'unissent aux colonnes avec une profondeur de 70 cm pour créer une armoire très fonctionnelle qui meuble les deux parois de l'espace ambiant et optimise l'espace à disposition.





Comp.618

01 Colonne / columns / colonnes
l. 255 x h. 250 x p. 35/50 cm

02 Basi / base units / éléments bas
l. 195 x h. 50 x p. 50 cm

Misure / mesures / mesures

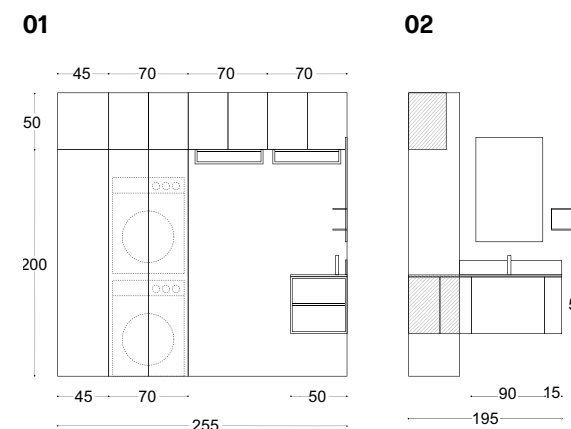

Melaminici / melamine / mélaminés

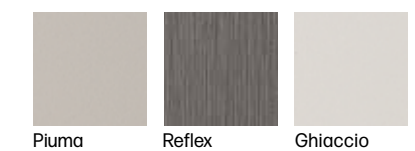



Comp.619

01 Colonne / columns / colonnes
l. 170 x h. 200 x p. 70 cm

02 Basi + colonne / base units + columns / éléments bas + colonnes
l. 180 x h. 50/162.5 x p. 50 cm

Misure / mesures / mesures

01

02

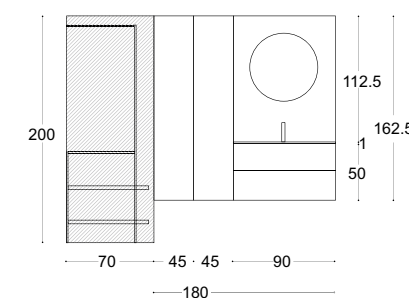
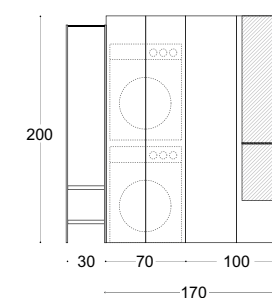

Laccato + melaminico / lacquer + melamine/ laqué + mélaminé

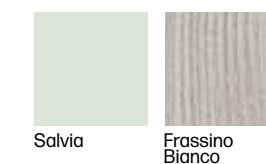



Ideal Laundry

La base ad angolo si inserisce nella profondità della colonna e tutto lo spazio viene pienamente sfruttato. Inoltre, nella composizione c'è un elemento di novità: il porta boiler che crea un vano tecnico molto utile.

The corner base unit is incorporated into the depth of the tall unit and every inch of space is fully utilised. In addition, the composition features a new element: the boiler door that creates a highly practical technical compartment for uniformity in the design.

L'élément bas d'angle s'insère dans la profondeur de la colonne et l'espace est pleinement exploité. De plus, dans la composition il y a un élément nouveau : le porte chauffe-eau qui crée une niche technique très utile pour ne pas interrompre l'esthétique de la buanderie.



Ideal Laundry

Comp. 620

01 Basi / base units / éléments bas
l. 230 x h. 87.5 x p. 70.5 cm

02 Colonne / columns / colonnes
l. 160 x h. 250 x p. 50 cm

03 Colonne / columns / colonnes
l. 90 x h. 250 x p. 50 cm

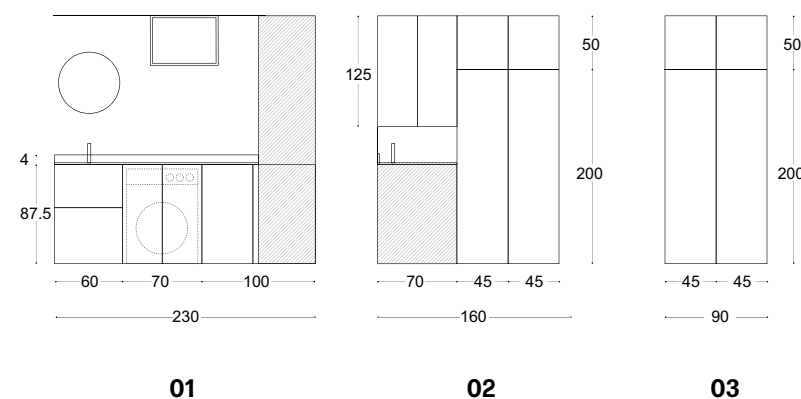

BASE PORTALAVATRICE

Lavatrice nascosta o a vista? Dipende dai gusti e dalle esigenze. Se la lavanderia coincide con l'unico e principale bagno di casa, appositi moduli con profondità 65 cm e doppia anta possono contenere anche gli elettrodomestici.

Laccato + melaminico / lacquer + melamine/ laqué + mélaminé



Terracotta

Frassino Naturale

• WASHING MACHINE BASE UNIT

Concealed or open washing machine? It depends on preferences and requirements. If the laundry room is also the main and only bathroom in the home, special modules with 65 cm depth and double doors can be used to contain appliances.

• ÉLÉMENT BAS POUR LAVE-LINGE

Lave-linge caché ou visible ? Cela dépend des goûts et des besoins. Si la buanderie coïncide avec l'unique et principale salle de bain, des modules spéciaux de profondeur 65 cm et double porte peuvent également contenir aussi les électroménagers.



La base ad angolo è molto capiente e, oltre a contenere, è un ampio piano di appoggio e di lavoro.

Comp. 621

01 Basi / base units / éléments bas
l. 240 x h. 87.5 x p. 70 cm

02 Basi + colonne / base units + columns / éléments bas + colonnes
l. 225 x h. 50/162.5 x p. 50/35 cm

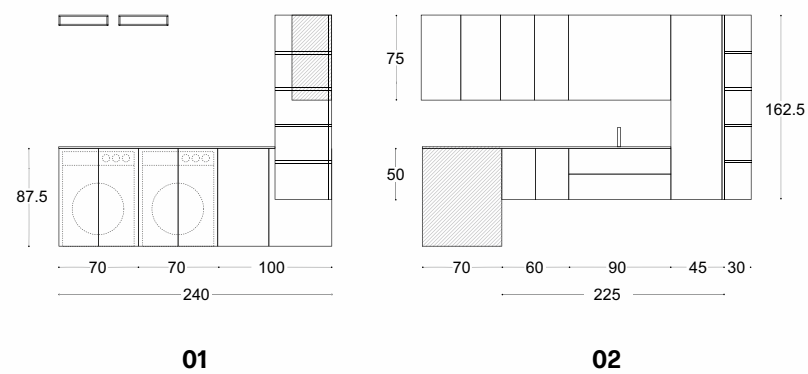

Melaminico + laccato / melamine + lacquer/ mélaminé + laqué



Rovere
Cognac

Beige

Floor-standing base units on one side and all-mounted units on the other, creating a dynamic environment.

D'un côté des éléments bas au sol et de l'autre suspendus pour créer un espace ambiant dynamique.



Ideal Laundry

I dettagli sono importanti: il piano in Idealcryn è una superficie continua, la maniglia Lama applicata sul bordo dell'anta è minimale e l'appendiabiti a parete è una presenza utile ma discreta.

Details are important: The Idealcryn top creates a continuous surface, the Lama handle applied to the edge of the door adds a minimalist touch and the wall-mounted clothing rail is practical yet discreet.

Les détails sont importants : le plan en Idealcryn est une surface continue, la poignée Lama appliquée sur le bord de la porte est minimale et les patères murales sont une présence utile mais discrète.





Ideal Laundry

Comp. 622

01 Basi / base units / éléments bas
l. 180 x h. 50/87.5 x p. 50/70 cm

02 Colonne / columns / colonnes
l. 120 x h. 200 x p. 50 cm

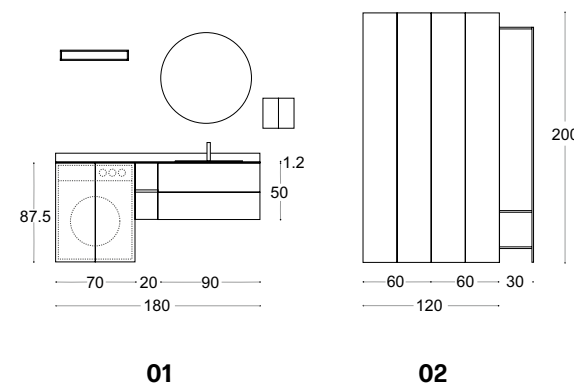

DOPPIA PROFONDITÀ

Si possono risolvere le problematiche degli spazi ridotti con una composizione a doppia profondità. Il piano sagomato e il nuovo elemento in metallo con ripiani in legno collegano le due basi tra loro, sia da un punto di vista funzionale, sia estetico.

• DOUBLE DEPTH

Problems of limited space can be resolved with a double-depth composition. The shaped top and new metal element with wooden shelving connect the two base units, in terms of function and aesthetics.

Laccato + melaminico / lacquer + melamine/ laqué + mélaminé



Oceano

Piuma

• DOUBLE PROFONDEUR

Il est possible de résoudre les problèmes des espaces réduits avec une composition avec double profondeur. La plan façonné et le nouvel élément en métal avec tablettes en bois relient les deux éléments bas entre eux, aussi bien d'un point de vue fonctionnel qu'esthétique.



Ideal Laundry

Quando la lavanderia è utilizzata anche come stanza guardaroba, può essere attrezzata con un'armadiatura a più ante. Sull'appendiabiti in metallo verniciato integrato sul fianco, trovano posto gli abiti appena indossati o stirati.

When the laundry area is also used as a wardrobe, it can be equipped with cupboards featuring multiple doors. The coated-metal clothing rail included on the side can hold all recently worn or ironed clothes.

Lorsque la buanderie est également utilisée comme penderie, elle peut être équipée d'une armoire avec plusieurs portes. Sur le porte-vêtements en métal peint intégré sur le côté, se trouvent les vêtements à peine portés ou repassés.





Comp.623

Composizione / composition / composition
 l. 175 x h. 200 x p. 50/70 cm

Misure / mesures / mesures

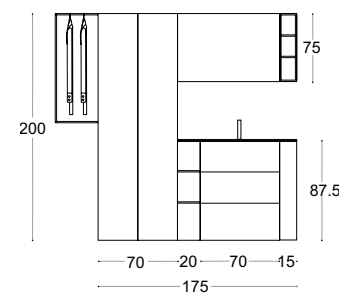

Laccati / lacquers / laqués

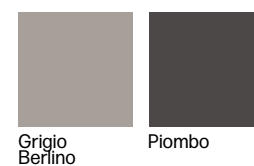

Comp.624

01 Basi / base units / éléments bas
 l. 180 x h. 50/87.5 x p. 50/70 cm
02 Basi + colonna / base units + columns / éléments bas + colonnes
 l. 170 x h. 87.5/200 x p. 35 cm

Misure / mesures / mesures

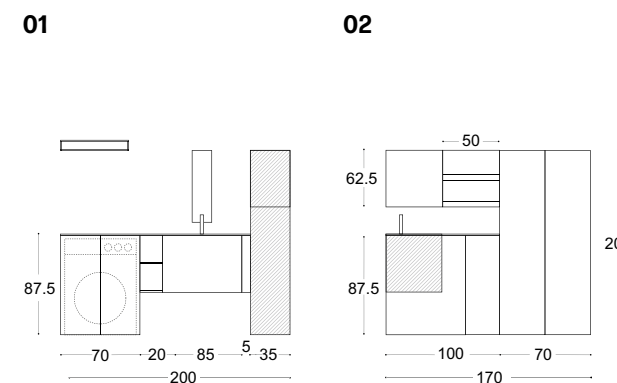

Melaminici + laccato / melamine + lacquer / mélaminés + laqué

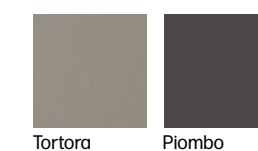



Ideal Laundry

Comp. 625

01 Colonne / columns / colonnes
l. 150 x h. 200 x p. 50 cm

02 Basi / base units / éléments bas
l. 275 x h. 50/87.5 x p. 50/70 cm

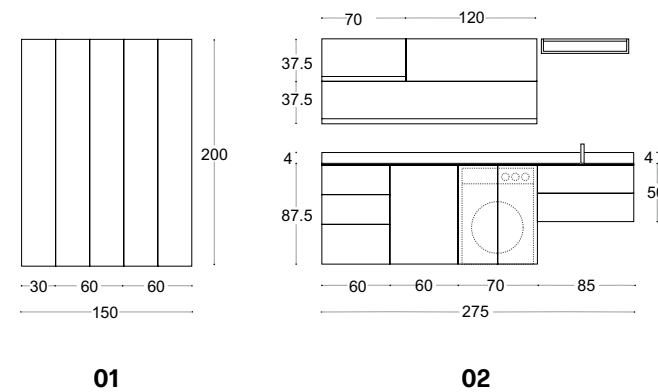

PIANO SAGOMATO

La composizione cambia profondità ma mantiene tutta la sua funzionalità: l'ingombro del lavabo si riduce per agevolare i movimenti all'interno della lavanderia senza rinunciare a un grande contenimento.

• SHAPED TOP

The depth of the composition changes but functionality is maintained: the space taken up by the washbasin is reduced for easier movement in the laundry area without compromising on excellent storage capacity.

Laccati + melaminico / lacquers + melamine/ laqués + mélaminé

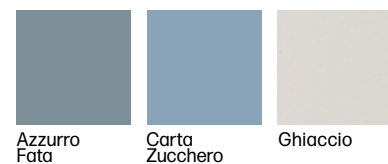

Azzurro Fata

Carta Zucchero

Ghiaccio

• PLAN FAÇONNÉ

La composition change de profondeur mais maintient toute sa fonctionnalité: l'encombrement du lavabo se réduit pour faciliter les mouvements à l'intérieur de la buanderie sans renoncer à un grand rangement.





Ideal Laundry

Negli ambienti di servizio, ogni elemento ha uno scopo: la barra a led sottopensile che illumina il piano di appoggio e lo stendibiancheria a parete in metallo verniciato che riprende lo stesso colore delle basi.

In utility environments, every element has a purpose: the LED strip lighting under the wall units illuminates the work surface and the coated-metal wall-mounted drying rack that uses the same colour as the base units.

Dans les espaces de service, chaque élément a un but : la barre à led sous-haut qui éclaire le plan d'appui et le séchoir mural en métal peint qui reprend le même coloris que celui des éléments bas.



La doppia profondità è unita da un unico piano sagomato che dà continuità alla composizione.

The double depth is unified with a single shaped top that gives the composition continuity.

La double profondeur est unie à un unique plan façonné qui donne de la continuité à la composition.

Comp. 626

Composizione / composition / composition
l. 140 x h. 200 x p. 50/70 cm

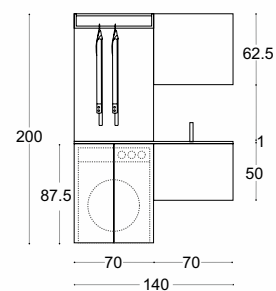

Laccato + melaminico / lacquer + melamine/ laqué + mélaminé



Verde Comodoro

Frassinio Bianco





Ideal Laundry

Comp. 627

01 Basi / base units / éléments bas
l. 253 x h. 50/87.5 x p. 35/50/70.5 cm

02 Colonne / columns / colonnes
l. 180 x h. 200 x p. 35 cm

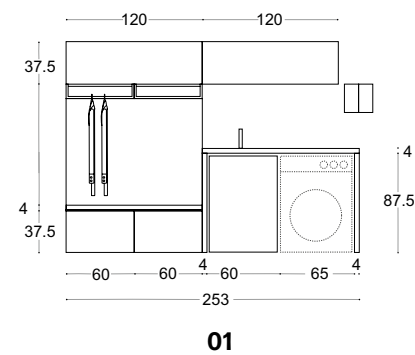

01

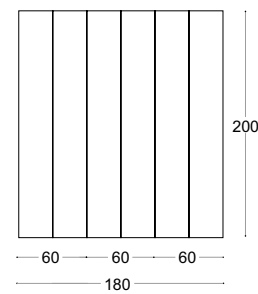

02

PANCHETTA

La base a terra con cassettoni diventa una pratica panca multifunzione: piano d'appoggio o seduta, in entrambi i casi è un elemento utile. Il piano in Rovere Nodato prosegue sulla parete e completa la lavanderia con una boiserie.

Laccato + melaminico / lacquer + melamine/ laqué + mélaminé



Grigio
Nabibia

Rovere
Nodato

• BENCH

The floor-standing base unit with deep drawers creates a practical multi-purpose bench: ideal for placing items or sitting, it always comes in handy. The top in Rovere Nodato finish continues on the wall and completes the laundry area with wood panelling.

• BANQUETTE

L'élément bas au sol avec grands tiroirs devient une pratique banquette multifonctions : plan d'appui ou assise, dans les deux cas c'est un élément utile. Le plan en Rovere Nodato continue sur la paroi et complète la buanderie avec un revêtement mural.



Ideal Laundry

CESTONE CON RUOTE

Il piano e i fianchi dal forte spessore racchiudono la lavatrice e un cestone estraibile con ruote, inserito sotto il lavabo. Un pratico portabiancheria che può essere facilmente spostato dove serve e facilmente rimesso al suo posto.



• WHEELED BASKET

Thick top and side elements contain the washing machine and a removeable wheeled basket, which rolls under the washbasin. This practical laundry basket can easily be moved wherever needed and returned to its place.

• PANIER AVEC ROULETTES

Le plan et les côtés de forte épaisseur renferment le lave-linge et un panier extractible avec roulettes, inséré sous le lavabo. Un pratique panier à linge qui peut être facilement déplacé là où il est nécessaire et facilement remis à sa place.



Ideal Laundry

In lavanderia ci sono molti elementi di novità: la doppia altezza delle basi, la boiserie decorativa, le luci a led sottopensile, l'appendiabiti applicato sotto i pensili e le mensole in metallo con schiena personalizzabile.

There are many new features in the laundry area: the double height of base units, decorative wood panelling, strip lighting under wall units, clothing rails below wall units and shelves in metal with customisable back.

Dans la buanderie il y a de nombreux éléments nouveaux : la double hauteur des éléments bas, le revêtement mural décoratif, l'éclairage à led sous-haut, les patères appliqués sous les éléments hauts et les étagères en métal avec fond personnalisable.



Con piani e fianchi dal forte spessore si possono realizzare progetti personalizzati.

Thick tops and side elements enable creation of customised projects.

Avec plans et côtés de forte épaisseur il est possible de réaliser des projets personnalisés.

Comp. 628

Composizione / composition / composition
l. 260 x h. 200 x p. 35/70.5 cm

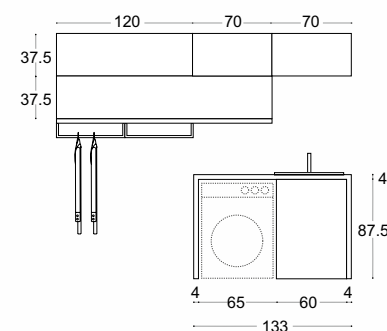

Laccati + Hpl / lacquer + hpl / laqué + hpl



Grigio Artico

Grigio Feltro

Hpl Zement





La penisola è il fulcro operativo della lavanderia.

The island is the core of the laundry area.

L'îlot est le cœur opérationnel de la buanderie.



Ideal Laundry

Comp. 629

01 Colonne / columns / colonnes
l. 280 x h. 137.5 x p. 50cm

02 Isola / island / îlot
l. 208 x h. 87.5 x p. 121 (50.5+70.5) cm

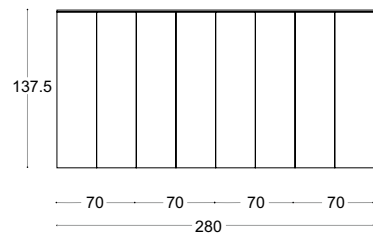

01

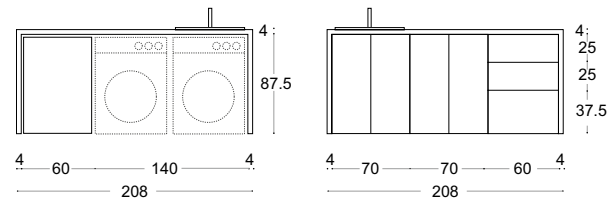

02

PENISOLA BIFACCIALE

I due lati della penisola sono entrambi attrezzati e, oltre al lavabo, il piano ha un'ampia superficie libera per lo stiro e altre attività. L'appendiabiti a soffitto aggiunge praticità.

• DOUBLE-SIDED ISLAND

The two sides of the island are both fully equipped and, in addition to the washbasin, the top features a large free surface for ironing and other tasks. Ceiling-mounted clothing rails are another practical touch.

Melaminico + laccato + Hpl / melamine + lacquer + hpl / mélaminé + laqué + hpl

Noce
Canaletto

Tamigi

Hpl
Zément

• ÎLOT DOUBLE FACE

Les deux côtés de l'îlot sont tous les deux équipés et, en plus du lavabo, le plan a une ample surface libre pour le repassage et autres activités. Les patères sur plafond ajoute de la praticité.



Ideal Laundry

Da un lato lavatrice, asciugatrice e cestone con ruote; dall'altro moduli con ante e cassettoni: l'isola/penisola è bifacciale e multifunzione. Con i piani e i fianchi dal forte spessore si possono creare progetti personalizzati.

On one side the washing machine, dryer and wheeled basket, and on the other modules with doors and deep drawers: a two-sided, multipurpose island. With thick tops and side elements, projects can be created with custom dimensions and finishes.

D'un côté lave-linge, sèche-linge et panier avec roulettes ; de l'autre modules avec portes et grands tiroirs : l'îlot est double face et multifonctions. Avec les plans et les côtés de forte épaisseur il est possible de créer des projets personnalisés dans les dimensions et les finitions.



Ideal Laundry



Comp.630

01 Colonne / columns / colonnes
l. 140 x h. 200 x p. 50 cm

02 Isola / island / îlot
l. 148 x h. 87.5 x p. 121 (50.5+70.5) cm

Misure / measures / mesures

01

02

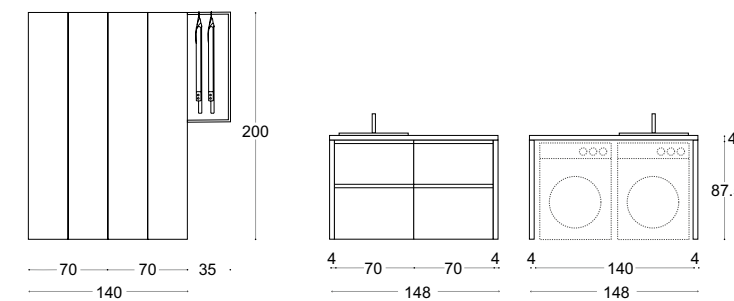

Melaminici + Hpl / melamines + hpl / mélaminés+ hpl





Ideal Laundry

Comp. 631

01 Colonne / columns / colonnes
l. 193 x h. 200 x p. 50 cm

02 Isola / island / îlot
l. 183 x h. 87.5 x p. 121 (50.5+70.5) cm

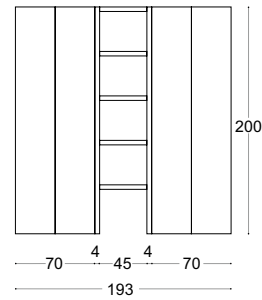

01

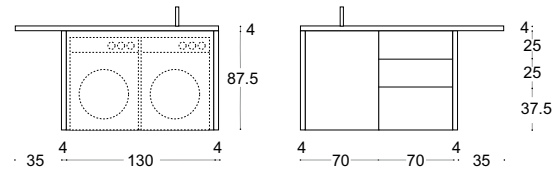

02

PIANO A SBALZO

La struttura dal forte spessore ha un piano a sbalzo, utile per lo stiro o anche per accomodarsi mentre si piega la biancheria o si aspetta che lavatrice e asciugatrice finiscano i loro programmi.

Melaminici / melamine / mélaminés



Rasato
Malta

Rovere
Cognac

• OVERHANGING TOP

The thick structure has an overhanging top, which is excellent for ironing, folding laundry or waiting for the washing machine or dryer programmes to finish.

• PLAN EN PORTE-À-FAUX

La structure de forte épaisseur a un plan en porte-à-faux, utile pour le repassage ou aussi pour s'installer lorsque l'on plie le linge ou lorsque l'on attend que le lave-linge et le sèche-linge terminent leurs programmes.



Ideal Laundry

La penisola con piano a sbalzo è attrezzata su entrambi i lati: lavatrice e asciugatrice da un lato, moduli contenitori dall'altro. Una soluzione intelligente che permette di arredare una lavanderia completa con un unico arredo.

The island with overhanging top is equipped on both sides: washing machine and dryer on one side, storage modules on the other. This is a clever solution that enables a complete laundry area to be fitted out with a single piece of furniture.

L'îlot avec plan en porte-à-faux est équipé sur les deux côtés : lave-linge et sèche-linge d'un côté, modules de rangement de l'autre. Une solution intelligente qui permet de meubler une buanderie complète avec un unique ameublement.



Ideal Laundry

La lavanderia viene finita e rifinita con altri elementi utili e, allo stesso tempo, esteticamente curati: le mensole in metallo con schiena personalizzabile decorano la parete e il cestone con ruote attrezza lo spazio dei vani a giorno.

The laundry area is finished and complemented with other useful elements, adding design features: metal shelves with custom backs decorate the wall and the wheeled metal basket makes use of space in open compartments.

La buanderie est finie avec d'autres éléments utiles et, à la fois, esthétiquement soignés : les étagères en métal avec fond personnalisable décorent la paroi et le panier en métal avec roulettes équipe l'espace des niches ouvertes.



• **MENSOLA DOUBLE CON FONDO**
 Double shelf with bottom
 Étagère Double avec fond

• **GRIGLIA STENDIBIANCHERIA**
 Clothesline
 Étendoir à linge

• **APPENDIABITI A PARETE**
 Coat rack wall
 Porte vêtements à paroi

• **APPENDIABITI A PARETE VERTICALE**
 Vertical wall coat rack
 Porte vêtements murale verticale

• **ELEMENTO LATERALE COLONNA / PARETE**
 Side element for column / wall
 Élément latéral pour colonne / parois

• **APPENDIABITI A SOFFITTO**
 Ceiling coat rack
 Porte vêtements au plafond

• **MENSOLA QUINTA CON FONDO**
 Quinta shelf with bottom
 Étagère Quinta avec fond

• **APPENDIABITI SOTTOPENSILE / SOTTOMENSOLA**
 Ceiling/under wall unit
 clothes rail
 Porte vêtements sous éléments hauts / étagère

• **GAMBA SOSTEGNO PIANI**
 Feet support plans
 Support pour plans

-- technical area

**Finiture, colori,
moduli e
composizioni:
tutto ciò che
serve per
progettare
la propria
lavanderia.**

Finishes, colours, modules and
compositions: everything needed to
design your laundry area.

Finitions, coloris, modules et
compositions : tout ce qui sert à
concevoir sa propre buanderie.

Finiture struttura e frontali

STRUCTURES AND FRONT-PANEL FINISHES • FINITIONS STRUCTURES ET FAÇADES

Melaminici Melamine · Mèlaminés



Laccati Soft Soft Lacquers · Laques Soft

*Abbinabili ai Top in Fenix Can be combined with Fenix Tops · Combinable avec les plans en Fenix

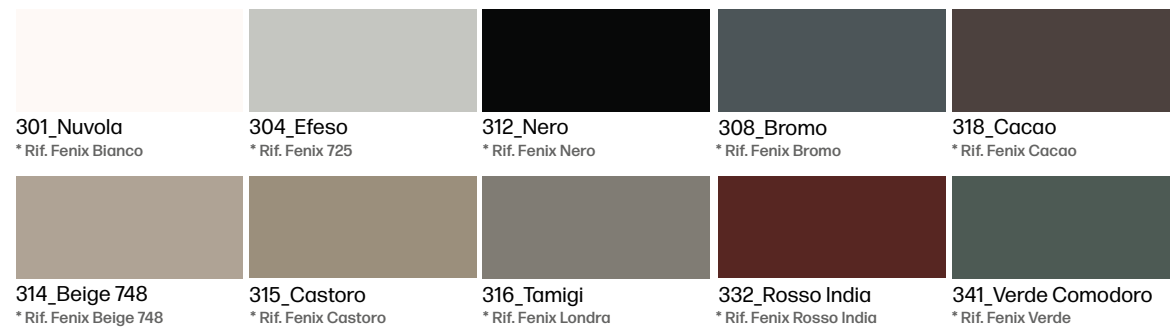

Metallizzati Metallic colours · Coloris métallisés



Laccati opachi e lucidi Matt and glossy lacquered · Laqués mates et brillants



Finiture top

TOP FINISHES · FINITIONS DU PLAN DE TOILETTE

Melaminici Melamine · Mèlaminés



Gres Stoneware · Grès



Gres lucidi High-gloss gres · Grès brillants



Idealcryn opachi e lucidi Matt and glossy Idealcryn · Idealcryn mates et brillants



HPL

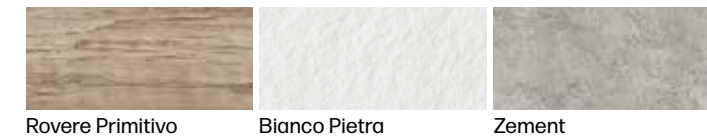

Tecnoril®

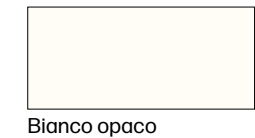

Riepilogo composizioni

OVERVIEW OF COMPOSITIONS · RÉCAPITULATIF DES COMPOSITIONS

Comp. 601

p. 12



Base e Colonne mel. Frassino naturale
Tavolo mel. Ghiaccio
Top IDEALCRYL® Sp.1.2 con vasca integrata
Maniglia Astra fin. Graffite 69
Appendiabiti a parete fin. Titanio

IT 01 Basi + tavolo
 I. 180/190 x h. 87.5 x p. 50 cm
02 Colonne
 I. 253 x h. 200 x p. 70 cm
03 Basi
 I. 270 x h. 85 x p. 50 cm

Melaminico Frassino naturale
Melaminico Ghiaccio

EN 01 Bases + table
 I. 180/190 x h. 87.5 x p. 50 cm
02 Columns
 I. 253 x h. 200 x p. 70 cm
03 Base units
 I. 255 x h. 85 x p. 50 cm

Melamine Frassino naturale
Melamine Ghiaccio

FR 01 Bases + table
 I. 180/190 x h. 87.5 x p. 50 cm
02 Colonne
 I. 253 x h. 200 x p. 70 cm
03 Éléments bas
 I. 255 x h. 85 x p. 50 cm

Mélatiné Frassino naturale
Mélatiné Ghiaccio

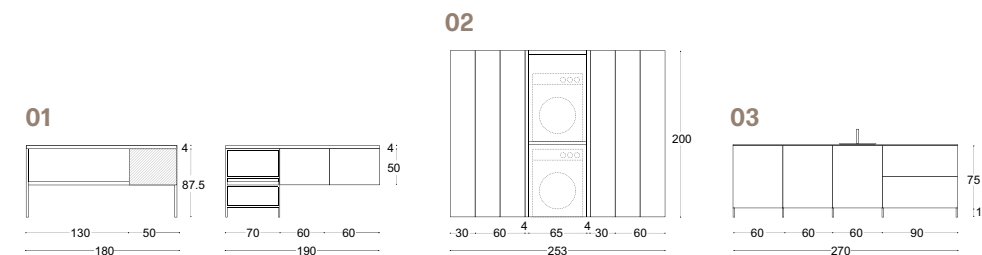

Comp. 602

p. 18



Base e Colonne lac. Tamigi opaco - mel. Noce Canaletto
Tavolo mel. Piasentina
Top forte spessore mel. Piasentina
Lavabo consolle IDEALCRYL® Sp.1.2
Maniglia Vela
Boiserie mel. Noce Canaletto
Appendiabiti a soffitto fin. Titanio

IT 01 Colonne
 I. 240 x h. 200 x p. 50 cm
02 Basi + tavolo
 I. 204 x h. 200 x p. 70 cm

Melaminico Noce Canaletto
Melaminico Piasentina
Laccato Tamigi opaco

EN 01 Columns
 I. 240 x h. 200 x p. 50 cm
02 Bases + table
 I. 204 x h. 200 x p. 70 cm

Melamine Noce Canaletto
Melamine Piasentina
Lacquer Tamigi opaco

FR 01 Colonne
 I. 240 x h. 200 x p. 50 cm
02 Bases + table
 I. 204 x h. 200 x p. 70 cm

Mélatiné Noce Canaletto
Mélatiné Piasentina
Laqué Tamigi opaco

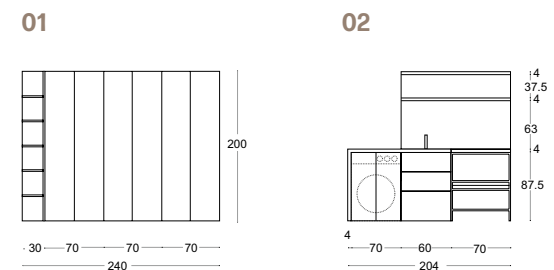

Comp. 603

p. 22



Base / Pensili mel. Rovere Nodato - mel. Vulcano
Top e struttura forte spessore mel. Vulcano
Lavabo in ceramica MAXI 70
Maniglia Vela
Appendiabiti fianco base fin. Bianco

IT Composizione
 I. 290 x h. 200 x p. 35/70.5 cm

Melaminico Rovere Nodato
Melaminico Vulcano

EN composition
 I. 290 x h. 200 x p. 35/70.5 cm

Melamine Rovere Nodato
Melamine Vulcano

FR composition
 I. 290 x h. 200 x p. 35/70.5 cm

Mélatiné Rovere Nodato
Mélatiné Vulcano

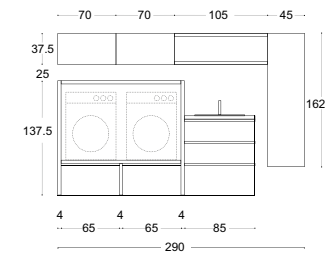

Comp. 604

p. 28



Base lac. Bosco
Colonna forte spessore mel. Rovere Nodato
Top consolle IDEALCRYL® Sp.1.2
Maniglia Vela
Specchio Basic con lampada Nice

IT 01 Colonne
 I. 142 x h. 200 x p. 50 cm
02 Basi
 I. 163 x h. 137.5 x p. 70.5 cm

Laccato Bosco
Melaminico Rovere Nodato

EN 01 Columns
 I. 180/190 x h. 87.5 x p. 50 cm
02 Base units
 I. 163 x h. 137.5 x p. 70.5 cm

Lacquer Bosco
Melamine Rovere Nodato

FR 01 Colonne
 I. 180/190 x h. 87.5 x p. 50 cm
02 Éléments bas
 I. 163 x h. 137.5 x p. 70.5 cm

Lacqué Bosco
Mélatiné Rovere Nodato

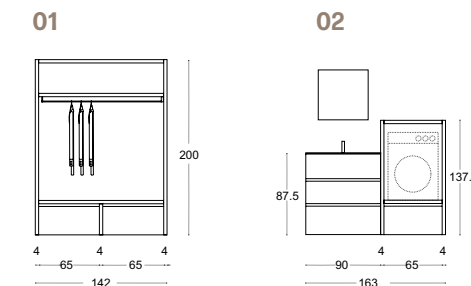

Comp. 605

p. 30



Base mel. Rasato Malta
Pensili lac. Fango opaco
Colonne mel. Ghiaccio
Top forte spessore mel. Rasato Malta
Lavabo in ceramica SCOTLAND 70
Specchio Frame
Maniglia Astra fin. acciaio spazzolato
Mensola Clock fin. Fango
Elemento laterale per colonna fin. Fango con mensola lac. Fango

IT 01 Colonne
 I. 210 x h. 200 x p. 50 cm
02 Basi
 I. 224 x h. 87.5 x p. 35/70.5 cm

Melaminico Rasato Malta
Melaminico Ghiaccio
Laccato Fango opaco

EN 01 Columns
 I. 210 x h. 200 x p. 50 cm
02 Base units
 I. 224 x h. 87.5 x p. 35/70.5 cm

Melamine Rasato Malta
Melamine Ghiaccio
Lacquer Fango opaco

FR 01 Colonne
 I. 210 x h. 200 x p. 50 cm
02 Éléments bas
 I. 224 x h. 87.5 x p. 35/70.5 cm

Mélatiné Rasato Malta
Mélatiné Ghiaccio
Lacqué Fango opaco

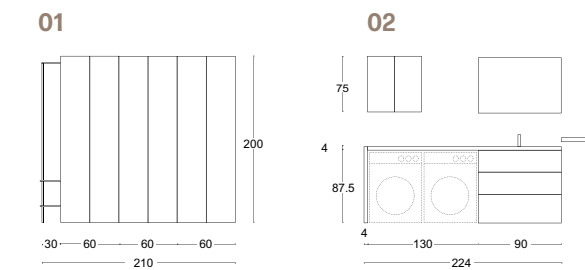

Comp. 606

p. 36



Base e pensili mel. Patagonia Grey - mel. Piuma
Colonna mel. Piuma
Top IDEALCRYL® Sp.1.2 con vasca integrata
Specchio Basic con lampada Light Plus
Mensola Clock finitura Titanio
Maniglia Bric Titanio
Appendiabiti fianco colonna finitura Titanio

IT 01 Colonne
 l. 142 x h. 137.5 x p. 70.5 cm
02 Basi
 l. 120 x h. 87.5 x p. 35/50 cm

Melaminico Patagonia Grey
Melaminico Piuma

01

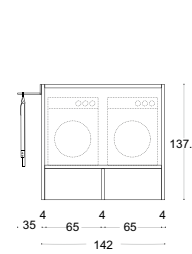

EN 01 Columns
 l. 142 x h. 137.5 x p. 70.5 cm
02 Base units
 l. 120 x h. 87.5 x p. 35/50 cm

Melamine Patagonia Grey
Melamine Piuma

02

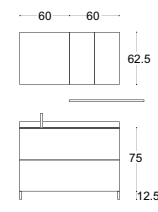

FR 01 Colonne
 l. 142 x h. 137.5 x p. 70.5 cm
02 Éléments bas
 l. 120 x h. 87.5 x p. 35/50 cm

Melaminé Patagonia Grey
Melaminé Piuma

Comp. 609

p. 44



Base mel. Rovere Gessato - mel. Piuma
Colonna mel. Rovere Gessato - mel. Piuma
Top forte spessore mel. Rovere Gessato
Lavabo in ceramica SCOTTLAND 70
Specchio Basic con lampada Nice
Boiserie mel. Piuma
Maniglia Astra Acciaio spazzolato
Elemento laterale per colonna fin. Titanio con mensola mel. Piuma

IT 01 Basi
 l. 154 x h. 191.5 x p. 70.5 cm
02 Colonne
 l. 226 x h. 200 x p. 50.5 cm

Melaminico Rovere Gessato
Melaminico Piuma

01

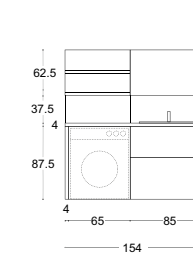

EN 01 Base units
 l. 154 x h. 191.5 x p. 70.5 cm
02 Columns
 l. 226 x h. 200 x p. 50.5 cm

Melamine Rovere Gessato
Melamine Piuma

02

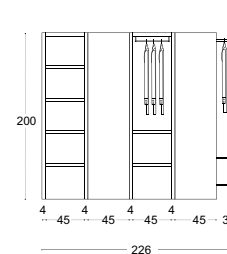

FR 01 Éléments bas
 l. 154 x h. 191.5 x p. 70.5 cm
02 Colonne
 l. 226 x h. 200 x p. 50.5 cm

Melaminé Rovere Gessato
Melaminé Piuma

Comp. 607

p. 37



Base e colonna mel. Nodato creta - lac. Fango
Base forte spessore mel. Nodato creta - lac. Fango
Top con vasca integrata semincasso B500
Specchio Basic con lampada Fly
Maniglia Astra Graffite 69
Mensola Double lac. Bianco - mel. Nodato Creta

IT 01 Basi
 l. 148 x h. 37.5 x p. 70.5 cm
02 Basi
 l. 130 x h. 162.5 x p. 35 cm

Melaminico Nodato Creta
Laccato Fango

01

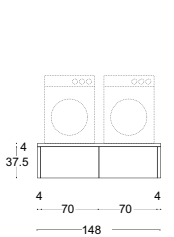

EN 01 Base units
 l. 148 x h. 37.5 x p. 70.5 cm
02 Base units
 l. 130 x h. 162.5 x p. 35 cm

Melamine Nodato Creta
Lacquer Fango

02

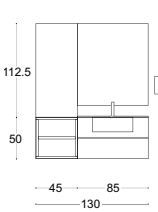

FR 01 Éléments bas
 l. 148 x h. 37.5 x p. 70.5 cm
02 Éléments bas
 l. 130 x h. 162.5 x p. 35 cm

Melaminé Nodato Creta
Laqué Fango

Comp. 610

p. 48



Base e colonne mel. Frassino Bianco
Top forte spessore mel. Frassino Bianco
Lavabo in ceramica SCOTTLAND 60
Specchio Strip
Maniglia Vela fin. Titanio
Mensola Clock fin. Titanio

IT 01 Colonne
 l. 113 x h. 200 x p. 50.5 cm
02 Basi
 l. 210 x h. 87.5 x p. 70.5 cm

Melaminico Frassino Bianco

01

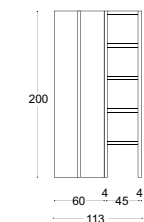

EN 01 Columns
 l. 113 x h. 200 x p. 50.5 cm
02 Base units
 l. 210 x h. 87.5 x p. 70.5 cm

Melamine Frassino Bianco

02

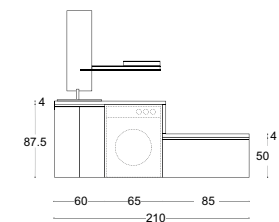

FR 01 Colonne
 l. 113 x h. 200 x p. 50.5 cm
02 Éléments bas
 l. 210 x h. 87.5 x p. 70.5 cm

Melaminé Frassino Bianco

Comp. 608

p. 38



Base e colonna lac. Pistacchio
Colonna forte spessore mel. Rovere Nodato
Top IDEALCRYL® Sp.1.2 con vasca integrata
Specchio Rot con boiserie mel. Rovere Nodato
Maniglia Vela lac. Pistacchio

IT Composizione
 l. 208 x h. 200 x p. 50.5 cm
Laccato Pistacchio
Melaminico Rovere Nodato

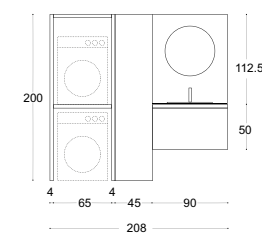

EN composition
 l. 208 x h. 200 x p. 50.5 cm
Lacquer Pistacchio
Melamine Rovere Nodato

FR composition
 l. 208 x h. 200 x p. 50.5 cm
Laqué Pistacchio
Mélatiné Rovere Nodato

Comp. 611

p. 54



Base mel. Piasentina - lac. Rosso India
Pensili lac. Rosa Quarzo
Top forte spessore mel. Frassino Bianco
Lavabo in ceramica MAXI 60
Specchio Rot con boiserie lac. Rosa Quarzo
Maniglia Lama fin. RossoIndia / Rosa Quarzo

IT Composizione
 l. 227 x h. 200 x p. 35/70.5 cm
Laccato Rosso India
Laccato Rosa Quarzo
Melaminico Piasentina

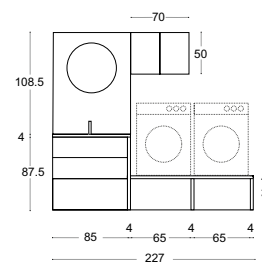

EN composition
 l. 227 x h. 200 x p. 35/70.5 cm
Lacquer Rosso India
Lacquer Rosa Quarzo
Melamine Piasentina

FR composition
 l. 227 x h. 200 x p. 35/70.5 cm
Laqué Rosso India
Laqué Rosa Quarzo
Mélatiné Piasentina

Comp. 612

p. 56



Base e colonne mel. Rasato Bianco - mel. Tortora
Top forte spessore mel. Frassino Bianco
Lavabo IDEALCRYL® Sp1.2
Maniglia Lama fin. Grigio Feltro
Appendiabiti a soffitto fin. Tortora
Elemento laterale per colonna fin. Grigio Feltro con mensole mel. Tortora

IT 01 Basi
 l. 234 x h. 87.5 x p. 70.5 cm
02 Basi
 l. 190 x h. 50 x p. 50 cm
03 Colonne
 l. 228 x h. 200 x p. 50 cm

Melaminico Rasato Bianco
Melaminico Tortora

01

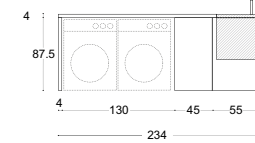

EN 01 Base units
 l. 234 x h. 87.5 x p. 70.5 cm
02 Base units
 l. 190 x h. 50 x p. 50 cm
03 Columns
 l. 228 x h. 200 x p. 50 cm

Melamine Rasato Bianco
Melamine Tortora

02

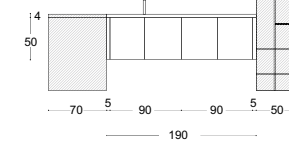

FR 01 Éléments bas
 l. 234 x h. 87.5 x p. 70.5 cm
02 Éléments bas
 l. 190 x h. 50 x p. 50 cm
03 Colonnes
 l. 228 x h. 200 x p. 50 cm

Melaminé Rasato Bianco
Melaminé Tortora

03

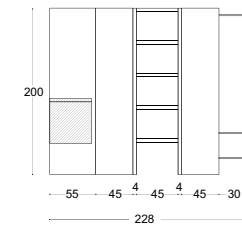

Comp. 613

p. 62



Base e pensili mel. Ghiaccio
Top forte spessore mel. Rovere Primitivo
Lavabo IDEALCRYL® Sp1.2
Maniglia Vela fin. Bianco
Appendiabiti sottopensile fin. Bianco

IT 01 Basi
 l. 184 x h. 87.5 x p. 70 cm
02 Basi
 l. 255 x h. 37.5 x p. 35/50 cm

Melaminico Rovere Primitivo
Melaminico Ghiaccio

01

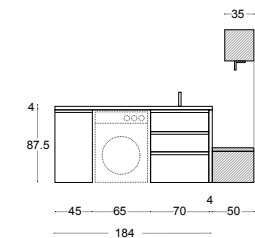

EN 01 Base units
 l. 184 x h. 87.5 x p. 70 cm
02 Base units
 l. 255 x h. 37.5 x p. 35/50 cm

Melamine Rovere Primitivo
Melamine Ghiaccio

02

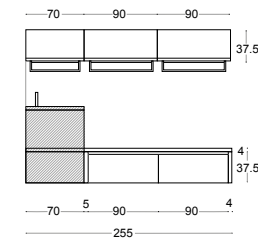

FR 01 Éléments bas
 l. 184 x h. 87.5 x p. 70 cm
02 Éléments bas
 l. 255 x h. 37.5 x p. 35/50 cm

Melaminé Rovere Primitivo
Melaminé Ghiaccio

Comp. 614

p. 63



Base mel. Frassino naturale / mel. Rasato Bianco
Top forte spessore mel. Rasato Bianco
Lavabo in ceramica MAXI 60
Specchio Basic con lampada Nice
Boiserie mel. Frassino naturale - mel. Rasato Bianco
Maniglia Bric fin. Graffite 69
Appendiabiti a parete fin. Bianco

IT 01 Basi
 l. 180 x h. 200 x p. 50 cm
02 Basi
 l. 135 x h. 87.5 x p. 70 cm

Melaminico Frassino Naturale
Melaminico Rasato Bianco

01

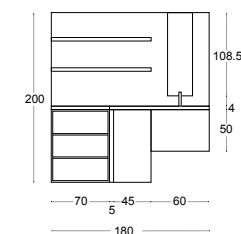

EN 01 Base units
 l. 180 x h. 200 x p. 50 cm
02 Base units
 l. 135 x h. 87.5 x p. 70 cm

Melamine Frassino Naturale
Melamine Rasato Bianco

02

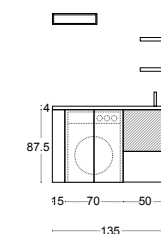

FR 01 Éléments bas
 l. 180 x h. 200 x p. 50 cm
02 Éléments bas
 l. 135 x h. 87.5 x p. 70 cm

Melaminé Frassino Naturale
Melaminé Rasato Bianco

Comp. 615

p. 64



Base mel. Patagonia brown
Pensili e colonna mel. Noce Canaletto - vetro Fumè
Top forte spessore mel. Patagonia Brown
Lavabo in ceramica SCOTTLAND 60
Specchio Basic con lampada Fly
Maniglia Vela fin. Cacao
Appendiabiti sottopensile fin. Cacao

IT Composizione
 l. 345 x h. 250 x p. 35/50/70 cm

Melaminico Noce Canaletto
Melaminico Patagonia Brown

EN composition
 l. 345 x h. 250 x p. 35/50/70 cm

Melamine Noce Canaletto
Melamine Patagonia Brown

FR composition
 l. 345 x h. 250 x p. 35/50/70 cm

Mélatiné Noce Canaletto
Mélatiné Patagonia Brown

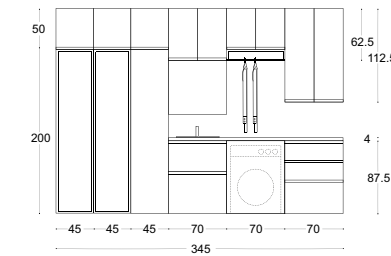

Comp. 616

p. 72



Base lac. Verde Nevada
Pensile mel. Ghiaccio - lac. Verde Nevada
Colonna mel. Ghiaccio
Top forte spessore mel. Ghiaccio
Lavabo in ceramica MAXI 60
Maniglia Vela fin. Verde Nevada
Appendiabiti fianco colonne e sottopensile fin. Bianco

IT Composizione
 l. 199 x h. 250 x p. 35/70 cm

Melaminico Ghiaccio
Laccato Verde Nevada

EN composition
 l. 199 x h. 250 x p. 35/70 cm

Melamine Ghiaccio
Lacquer Verde Nevada

FR composition
 l. 199 x h. 250 x p. 35/70 cm

Mélatiné Ghiaccio
Laqué Verde Nevada

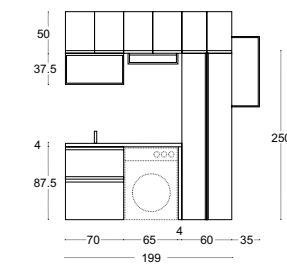

Comp. 617

p. 74



Base mel. Rovere Gessato
Colonne mel. Piuma
Top con vasca integrata semincasso B500
Specchio Basic con lampada Fly
Mensola Clock fin. Piombo
Maniglia Astra fin. Graffite 69
Elemento laterale per colonna fin. Bianco con mensole mel. Piuma

IT 01 Colonne
 l. 158 x h. 200 x p. 70.5 cm
02 Basi + colonne
 l. 255 x h. 87.5/200 x p. 35 cm

Melaminico Piuma
Melaminico Rovere Gessato

01

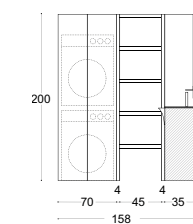

EN 01 Columns
 l. 158 x h. 200 x p. 70.5 cm
02 Base units + columns
 l. 255 x h. 87.5/200 x p. 35 cm

Melamine Piuma
Melamine Rovere Gessato

02

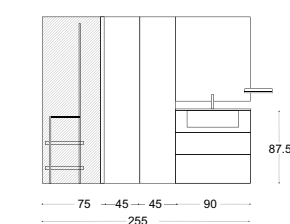

Comp. 618 p. 80



Base mel. Ghiaccio - mel. Reflex
 Pensili e colonna mel. Piuma
 Top IDEALCRYL® Sp.1.2 con vasca integrata
 Specchio Basic con lampada Light plus
 Maniglia Bric lac. Piombo
 Mensola Double lac. Piombo - mel. Piuma
 Appendiabiti sottopensile fin. Piombo

IT 01 Colonne
 l. 255 x h. 250 x p. 35/50 cm
 02 Basi
 l. 195 x h. 50 x p. 50 cm

Melaminico Piuma
 Melaminico Reflex
 Melaminico Ghiaccio

01

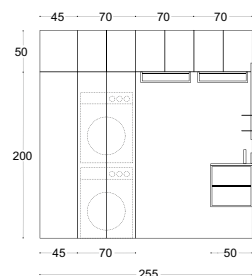

EN 01 Columns
 l. 255 x h. 250 x p. 35/50 cm
 02 Base units
 l. 195 x h. 50 x p. 50 cm

Melamine Piuma
 Melamine Reflex
 Melamine Ghiaccio

02

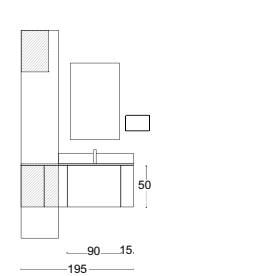

FR 01 Colonne
 l. 255 x h. 250 x p. 35/50 cm
 02 Éléments bas
 l. 195 x h. 50 x p. 50 cm

Melaminé Piuma
 Melaminé Reflex
 Melaminé Ghiaccio

Comp. 619 p. 82



Base e colonna sospesa lac. Salvia
 Colonna mel. Frassino Bianco
 Top IDEALCRYL® Sp.1.2 con vasca integrata
 Specchio Rot con boiserie mel. Frassino Bianco
 Maniglia Lama lac. Salvia
 Elemento laterale per colonna fin. Bianco con
 mensole lac. Salvia

IT 01 Colonne
 l. 170 x h. 200 x p. 70 cm
 02 Basi + colonne
 l. 180 x h. 50/162.5 x p. 50 cm

Melaminico Frassino Bianco
 Laccato Salvia

01

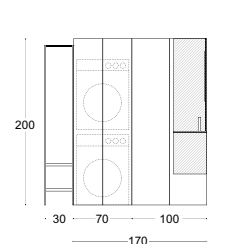

EN 01 Columns
 l. 170 x h. 200 x p. 70 cm
 02 Base units + columns
 l. 180 x h. 50/162.5 x p. 50 cm

Melamine Frassino Bianco
 Lacquer Salvia

02

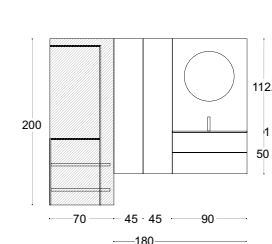

FR 01 Colonne
 l. 170 x h. 200 x p. 70 cm
 02 Éléments bas + colonnes
 l. 180 x h. 50/162.5 x p. 50 cm

Melaminé Frassino Bianco
 Laqué Salvia

Comp. 620 p. 84



Base mel. Frassino naturale
 Pensili e colonne lac. Terracotta
 Top TECNORIL® Sp.1.2 con vasca integrata
 Specchio Rot
 Maniglia Bric fin. Graffite 69
 Appendiabiti a parete fin. Piombo

IT 01 Basi
 l. 230 x h. 87.5 x p. 70.5 cm
 02 Colonne
 l. 160 x h. 250 x p. 50 cm
 03 Colonne
 l. 90 x h. 250 x p. 50 cm

Melaminico Frassino Naturale
 Laccato Terracotta

01

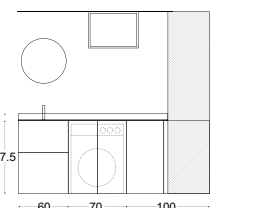

EN 01 Base units
 l. 230 x h. 87.5 x p. 70.5 cm
 02 Columns
 l. 160 x h. 250 x p. 50 cm
 03 Columns
 l. 90 x h. 250 x p. 50 cm

Melamine Frassino Naturale
 Lacquer Terracotta

02

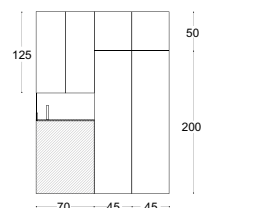

FR 01 Éléments bas
 l. 230 x h. 87.5 x p. 70.5 cm
 02 Colonne
 l. 160 x h. 250 x p. 50 cm
 03 Colonne
 l. 90 x h. 250 x p. 50 cm

Melaminé Frassino Naturale
 Laqué Terracotta

03

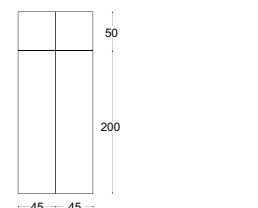

Comp. 621 p. 90



Base mel. Rovere Cognac - lac. Beige
 Pensili e colonna lac. Beige
 Elemento a giorno mel. Rovere Cognac - lac. Beige
 Top IDEALCRYL® Sp.1.2 con vasca integrata
 Specchio Basic con lampada Light Plus
 Maniglia Lama fin. Beige
 Appendiabiti a parete fin. Bianco

IT 01 Colonne
 l. 240 x h. 87.5 x p. 70 cm
 02 Basi + colonne
 l. 225 x h. 50/162.5 x p. 50/35 cm

Melaminico Rovere Cognac
 Laccato Beige

01

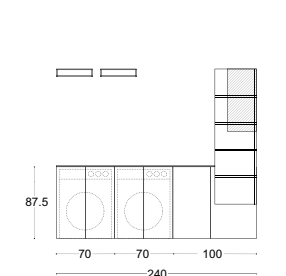

EN 01 Columns
 l. 240 x h. 87.5 x p. 70 cm
 02 Base units + columns
 l. 225 x h. 50/162.5 x p. 50/35 cm

Melamine Rovere Cognac
 Lacquer Beige

02

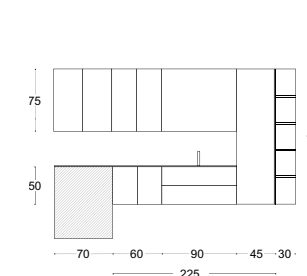

FR 01 Colonne
 l. 240 x h. 87.5 x p. 70 cm
 02 Éléments bas + colonnes
 l. 225 x h. 50/162.5 x p. 50/35 cm

Melaminé Rovere Cognac
 Laqué Beige

Comp. 622 p. 94



Base lac. Oceano
 Colonna mel. Piuma
 Top TECNORIL® Sp.1.2 a misura doppia profondità con
 vasca integrata
 Specchio Rot
 Maniglia Vela fin. Oceano
 Mensola Quinta lac. bianco - lac. Oceano
 Appendiabiti a parete fin. Oceano
 Elemento laterale per colonna fin. Oceano con
 mensole lac. Oceano

IT 01 Basi
 l. 230 x h. 87.5 x p. 70.5 cm
 02 Colonne
 l. 160 x h. 250 x p. 50 cm

Melaminico Piuma
 Laccato Oceano

01

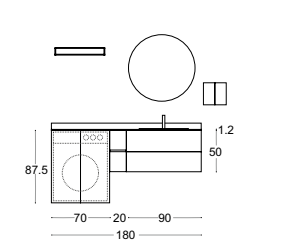

EN 01 Base units
 l. 230 x h. 87.5 x p. 70.5 cm
 02 Columns
 l. 160 x h. 250 x p. 50 cm

Melamine Piuma
 Lacquer Oceano

02

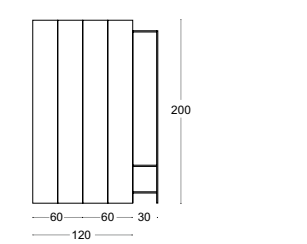

FR 01 Éléments bas
 l. 230 x h. 87.5 x p. 70.5 cm
 02 Colonne
 l. 160 x h. 250 x p. 50 cm

Melaminé Piuma
 Laqué Oceano

Comp. 623 p. 100



Base e colonna lac. Grigio Berlino
 Elemento di raccordo lac. Piombo
 Pensile a giorno lac. Grigio Berlino
 Top TECNORIL® Sp.1.2 a misura doppia profondità
 con vasca integrata
 Specchio contenitore con lampada Thin
 Maniglia Astra fin. Graffite 69

IT Composizione
 l. 175 x h. 200 x p. 50/70 cm
 Laccato Grigio Berlino
 Laccato Piombo

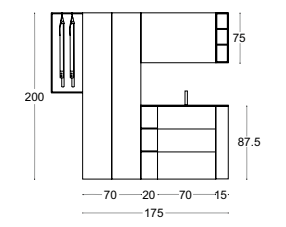

EN composition
 l. 175 x h. 200 x p. 50/70 cm
 Lacquer Grigio Berlino
 Lacquer Piombo

FR composition
 l. 175 x h. 200 x p. 50/70 cm
 Laqué Grigio Berlino
 Laqué Piombo

Comp. 624

p. 101



Base, pensile e colonna mel. Tortora
Elemento di raccordo lac. Piombo
Top IDEALCRYL® Sp.1.2 a misura doppia profondità con vasca integrata
Specchio Basic con lampada Light plus
Maniglia Astra fin. Graffite 69
Boiserie con mensola lac. Piombo
Appendiabiti a parete fin. Piombo

IT 01 Basi
 l. 180 x h. 50/87.5 x p. 50/70 cm
02 Basi + colonne
 l. 170 x h. 87.5/200 x p. 35 cm

**Melaminico Tortora
 Laccato Beige**

01

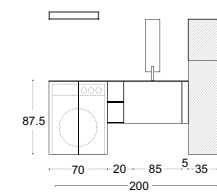

EN 01 Base units
 l. 180 x h. 50/87.5 x p. 50/70 cm
02 Base units + columns
 l. 170 x h. 87.5/200 x p. 35 cm

**Melamine Tortora
 Lacquer Beige**

02

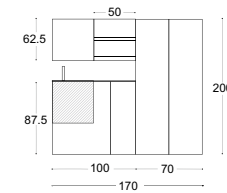

FR 01 Éléments bas
 l. 180 x h. 50/87.5 x p. 50/70 cm
02 Éléments bas + colonnes
 l. 170 x h. 87.5/200 x p. 35 cm

**Melaminé Tortora
 Laqué Beige**

Comp. 627

p. 112



Base forte spessore mel. Rovere Nodato - lac. Grigio Nabibia
Pensile lac. Grigio Nabibia
Colonna mel. Rovere Nodato
Boiserie mel. Rovere Nodato
Lavabo in ceramica MAXI 60
Maniglia Vela lac. Grigio Nabibia
Mensola Quinta mel. Rovere Nodato - lac. Grigio Nabibia
Appendiabiti sottopensile lac. Grigio Nabibia

IT 01 Basi
 l. 253 x h. 50/87.5 x p. 35/50/70.5 cm
02 Colonne
 l. 180 x h. 200 x p. 35 cm

**Laccato Grigio Nabibia
 Melaminico Rovere Nodato**

01

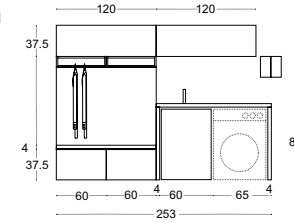

EN 01 Base units
 l. 253 x h. 50/87.5 x p. 35/50/70.5 cm
02 Columns
 l. 180 x h. 200 x p. 35 cm

**Lacquer Grigio Nabibia
 Melamine Rovere Nodato**

02

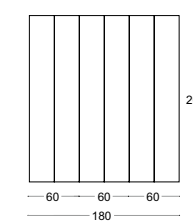

FR 01 Éléments bas
 l. 253 x h. 50/87.5 x p. 35/50/70.5 cm
02 ÉColonnes
 l. 180 x h. 200 x p. 35 cm

**Laqué Grigio Nabibia
 Melaminé Rovere Nodato**

Comp. 625

p. 102



Base lac. Carta Zucchero
Pensile e colonna lac. AzzurroFata
Top TECNORIL® Sp.1.2 con vasca integrata
Maniglia Lama lac. Carta Zucchero - lac. Azzurro Fata
Boiserie mel. Ghiaccio con mensola lac. Azzurro Fata
Appendiabiti a parete lac. Azzurro Fata

IT 01 Colonne
 l. 150 x h. 200 x p. 50 cm
02 Basi
 l. 275 x h. 50/87.5 x p. 50/70 cm

**Laccato Azzurro Fata
 Laccato Carta Zucchero
 Melaminico Ghiaccio**

01

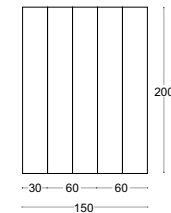

EN 01 Columns
 l. 150 x h. 200 x p. 50 cm
02 Base units
 l. 275 x h. 50/87.5 x p. 50/70 cm

**Lacquer Azzurro Fata
 Lacquer Carta Zucchero
 Melamine Ghiaccio**

02

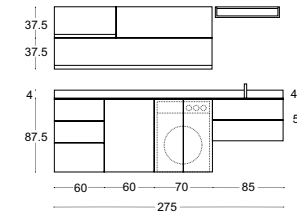

FR 01 Colones
 l. 150 x h. 200 x p. 50 cm
02 Éléments bas
 l. 275 x h. 50/87.5 x p. 50/70 cm

**Laqué Azzurro Fata
 Laqué Carta Zucchero
 Melaminé Ghiaccio**

Comp. 628

p. 120



Base, pensile forte spessore Hpl Zement / lac. Verde Comodoro
Pensile lac. Verde Comodoro
Boiserie con mensola lac. Verde Comodoro
Lavabo Idealcryl
Maniglia Vela lac. Verde Comodoro
Appendiabiti sottopensile lac. Piombo

IT Composizione
 l. 260 x h. 200 x p. 35/70.5 cm

**Laccato Verde Comodoro
 Laccato Verde Comodoro
 Hpl Zement**

01

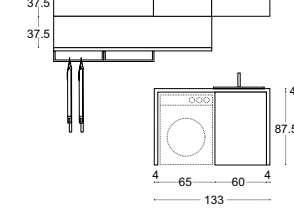

EN composition
 l. 260 x h. 200 x p. 35/70.5 cm

**Lacquer Verde Comodoro
 Lacquer Verde Comodoro
 Hpl Zement**

02

FR composition
 l. 260 x h. 200 x p. 35/70.5 cm

**Laqué Verde Comodoro
 Laqué Verde Comodoro
 Hpl Zement**

Comp. 626

p. 110



Base lac. Verde Comodoro
Top IDEALCRYL® Sp.1.2 a misura doppia profondità con vasca integrata lac. Verde Comodoro
Maniglia Lama lac. Verde Comodoro
Boiserie mel. Frassinio Bianco
Appendiabiti a parete lac. Bianco

IT Composizione
 l. 140 x h. 200 x p. 50/70 cm

**Laccato Verde Comodoro
 Melaminico Frassinio Bianco**

01

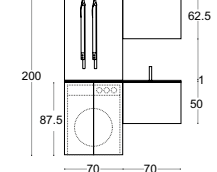

EN composition
 l. 140 x h. 200 x p. 50/70 cm

**Lacquer Verde Comodoro
 Melamine Frassinio Bianco**

02

FR composition
 l. 140 x h. 200 x p. 50/70 cm

**Laqué Verde Comodoro
 Melaminé Frassinio Bianco**

Comp. 629

p. 122



Base forte spessore Hpl Zement - lac. Tamigi
Colonne mel. Noce Canaletto
Lavabo in ceramica SCOTTLAND 60
Maniglia Lama lac. Tamigi
Mensole Double Hpl Zement - lac. Tamigi
Appendiabiti a soffitto lac. Tamigi

IT 01 Colonne
 l. 280 x h. 137.5 x p. 50cm
02 Isola
 l. 208 x h. 87.5 x p. 121 (50.5+70.5) cm

**Melaminico Noce Canaletto
 Laccato Tamigi
 Hpl Zement**

01

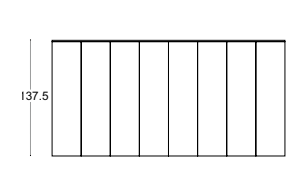

EN 01 Columns
 l. 280 x h. 137.5 x p. 50cm
02 Island
 l. 208 x h. 87.5 x p. 121 (50.5+70.5) cm

**Melamine Noce Canaletto
 Lacquer Tamigi
 Hpl Zement**

02

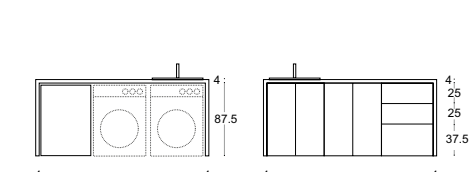

FR 01 Colones
 l. 280 x h. 137.5 x p. 50cm
02 Îlot
 l. 208 x h. 87.5 x p. 121 (50.5+70.5) cm

**Melaminé Noce Canaletto
 Laqué Tamigi
 Hpl Zement**

Comp. 630

p. 130



Base forte spessore Hpl Bianco Pietra - mel. Nodato Creta
Colonna mel. Nodato Piuma
Lavabo in ceramica SCOTTLAND 60
Maniglia Vela lac. Bianco
Appendiabiti fianco colonna lac. Bianco

IT 01 Colonne
 l. 140 x h. 200 x p. 50 cm
02 Isola
 l. 148 x h. 87.5 x p. 121 (50.5+70.5) cm

Melaminico Nodato Creta
Melaminico Piuma
Hpl Bianco Pietra

01

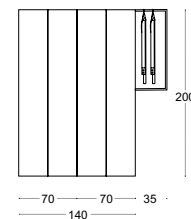

EN 01 Columns
 l. 140 x h. 200 x p. 50 cm
02 Island
 l. 148 x h. 87.5 x p. 121 (50.5+70.5) cm

Melamine Nodato Creta
Melamine piuma
Hpl Bianco Pietra

02

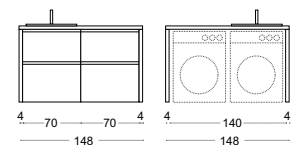

FR 01 Colonne
 l. 140 x h. 200 x p. 50 cm
02 Îlot
 l. 148 x h. 87.5 x p. 121 (50.5+70.5) cm

Melaminé Nodato Creta
Melaminé Piuma
Hpl Bianco Pietra

Comp. 631

p. 134



Base forte spessore mel. Rasato Malta
Colonne mel. Rasato Malta - mel. Noce Canaletto
Lavabo in ceramica MAXI 60
Maniglia Vela lac. Bianco
Mensole Double mel. Noce Canaletto - lac. Bianco
Appendiabiti a soffitto lac. Bianco

IT 01 Basi
 l. 253 x h. 50/87.5 x p. 35/50/70.5 cm
02 Colonne
 l. 180 x h. 200 x p. 35 cm

Melaminico Rasato Malta
Melaminico Rovere Cognac

01

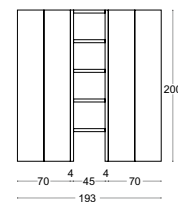

EN 01 Base units
 l. 253 x h. 50/87.5 x p. 35/50/70.5 cm
02 Columns
 l. 180 x h. 200 x p. 35 cm

Melamine Rasato Malta
Melamine Rovere Cognac

02

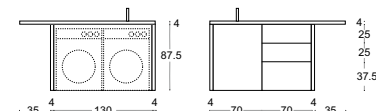

FR 01 Éléments bas
 l. 253 x h. 50/87.5 x p. 35/50/70.5 cm
02 ÉColonne
 l. 180 x h. 200 x p. 35 cm

Melaminé Rasato Malta
Melaminé Rovere Cognac

Design & progetto grafico
Internistudio

Foto
Studio Auber

Fotolito e stampa
Grafiche Antiga spa

Stampato
Gennaio 2023



stampato
con il sole

