

BATHROOM

IDEAL BAGNI

DISCOVERING
IBEY
COLLECTION
2022



IDEALBAGNI

BATHROOM

IDEAL BAGNI

ibey collection



IDEALBAGNI

^{IT} Progettare con attenzione il bagno significa creare un ambiente tutto per sé e per la cura del proprio corpo. La scelta delle finiture e dei colori, la tipologia di arredi, la disposizione dei moduli, la scelta dei dettagli: qualunque sia la dimensione dello spazio è possibile realizzare una stanza personalizzata nello stile e nella praticità. Grazie alla qualità, alla modularità, alle lavorazioni su misura e alla sartorialità di Ideal Bagni, l'ambiente bagno è proprio come lo hai sempre desiderato.

^{EN} Furnishing and decorating a bathroom means blending together functional and aesthetic features. Today Ideal Bagni bathroom vanities, units, tops come in all sorts of shapes and sizes, colours and finishes: whatever the space available is, a custom-made bathroom can be designed as per your own style and wish thanks to our quality, wide range of elements and tailor-made solutions.

^{FR} Créer une salle de bain veut dire mélanger les détails fonctionnels et esthétiques pour réaliser un espace où on prend soin de son corps. Aujourd'hui Ideal Bagni offre les éléments sous-lavabos, les éléments muraux et les plans dans une vaste gamme de formes, dimensions, coloris et finitions : quel que soit l'espace disponible, une salle de bain sur mesure peut être réalisée selon son propre goût et souhait grâce à la qualité, la gamme large des articles et les solutions sur mesure.

-- Company profile

Ideal Bagni è una realtà dinamica e in continua evoluzione nel settore dell'arredobagno, rinnovata nelle tecnologie, nel design e nelle collezioni. Nuove logiche produttive, tante possibilità di personalizzazione e un'ampia gamma di finiture sono gli elementi chiave di un'azienda al passo con i tempi, capace di rispondere a tutte le esigenze.

^{EN} Ideal Bagni is a dynamic company which carries on a no-stop research in the bathroom furnishing field. It has recently renewed the production technologies, the design and most of the collections, allowing the company to reply to any requirement thanks to its brand-new proposal and extensive range of colour and material combinations.

^{FR} Ideal Bagni est une société dynamique toujours en évolution. Elle s'est renouvelée au niveau de la technologie, de la production et de son design en présentant des nouvelles collections dans une vaste gamme des finitions qui permet de répondre à toutes les exigences.

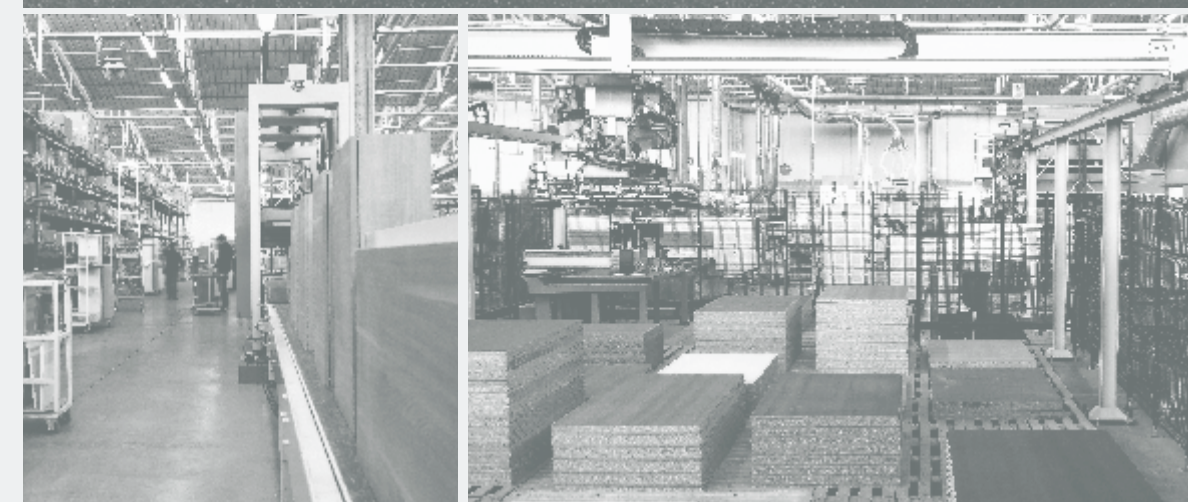

BATHROOM

MONOBLOCCHI PER OGNI SPAZIO

IBEY COLLECTION

Soluzioni essenziali per arredare grandi e piccoli ambienti.

^{EN} Essential solutions for furnishing large and small spaces.

^{FR} Des solutions essentielles pour l'ameublement de grands et petits espaces.

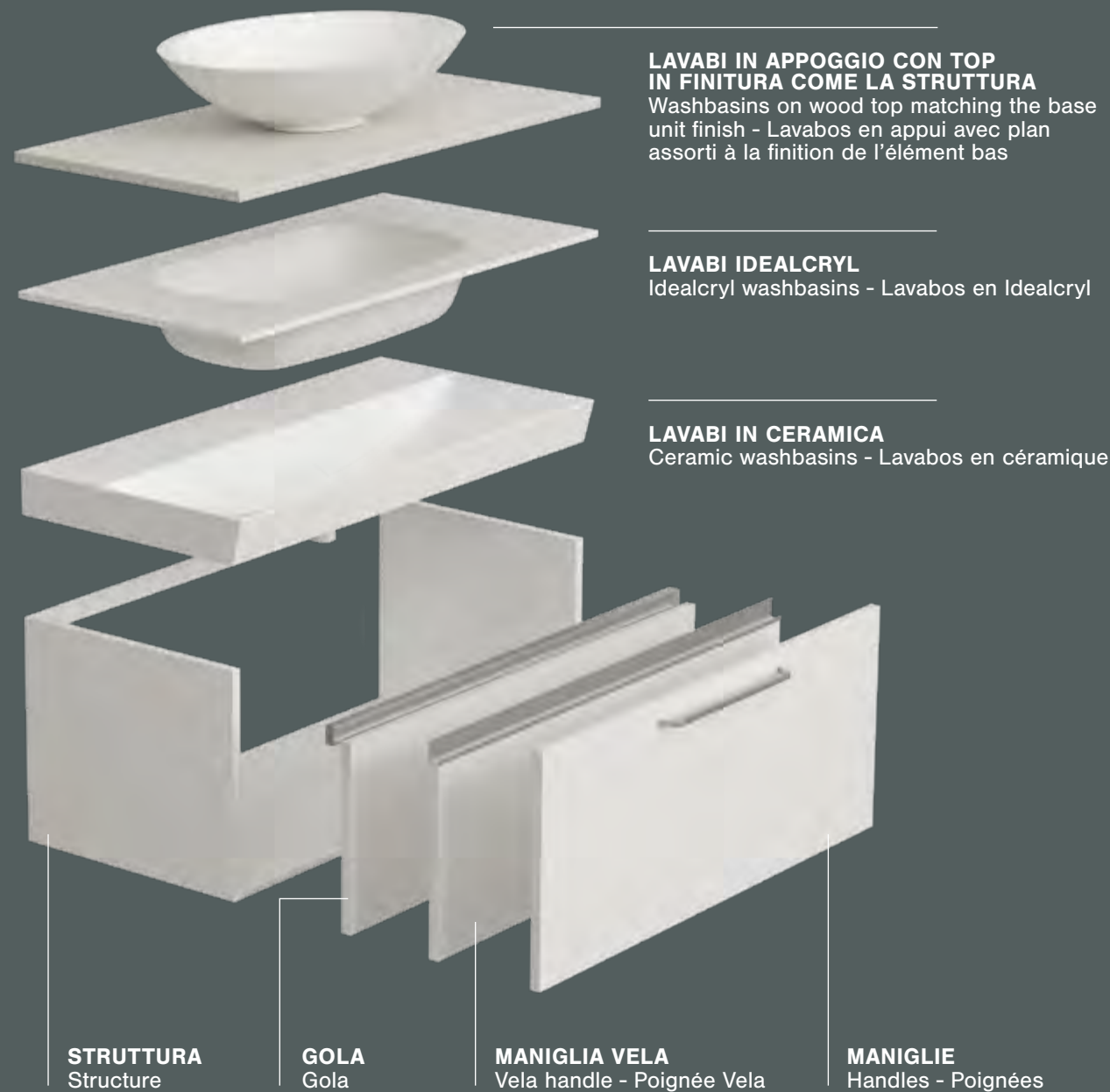

Gola

Profilo sagomato tra top e anta in varie finiture permette l'apertura mantenendo un design senza fronzoli.

^{EN} Gola

Shaped profile between top and door in various finishes allows opening while maintaining a design without frills.

^{FR} Gola

Le profil formé entre le plan et la porte dans diverses finitions permet l'ouverture tout en maintenant un design sans fioritures.



Maniglia Vela

La maniglia Vela è integrata nel bordo superiore dell'anta e può avere diverse colorazioni.

^{EN} Vela handle

Vela handle is integrated into the upper edge of the front and it can be in different colors.

^{FR} Poignée Vela

La poignée Vela est dans le bord supérieur de la façade et on peut l'avoir en différentes couleurs.



Maniglie

Diverse tipologie di maniglie caratterizzano il frontale.

^{EN} Handles

Different types of handles characterize the front.

^{FR} Poignées

Différents types de poignées caractérisent la façade.

NUOVE FINITURE MELAMINICHE

New melamine finishes - Nouvelles finitions des mélaminés

La gamma dei melaminici si arricchisce di nuove tonalità e matericità per offrire soluzioni ancora più ricercate, che oltre al valore estetico garantiscono resistenza e durata nel tempo.

The range of melamine finishes is enriched with new shades and new textures to offer even more refined solutions that give aesthetic value and guarantee resistance and durability over time.

La gamme des mélaminés s'enrichit de nouvelles teintes et de nouvelles textures pour offrir des solutions encore plus raffinées qui donnent une valeur esthétique et garantissent résistance et durabilité dans le temps.

Versatilità e personalizzazione

EN Versatility and customization - FR Versatilité et personnalisation

AMPIA MODULARITÀ

Wide modularity - Riche modularité



Diverse altezze, larghezze e profondità permettono di adattare la base lavabo allo spazio disponibile ed è possibile aggiungere contenimento utilizzando gli elementi accosto.

Different heights, widths and depths make it possible to adapt the washbasin base unit to the available space and it is possible to add storage using the base units.

Différentes hauteurs, largeurs et profondeurs permettent d'adapter l'élément bas lavabo à l'espace disponible et il est possible d'ajouter des rangements en utilisant les éléments bas.

Tante misure per tutti gli spazi

^{EN} Many sizes for all spaces

^{FR} De nombreuses mesures pour tous les espaces

ELEMENTI ACCOSTO

Side base units - Éléments bas latéraux



Vani a giorno, cassetti, cassettoni e moduli con ante di varie misure si affiancano alle basi lavabo per aumentare lo spazio disponibile e completare l'arredo bagno senza la necessità di un top di finitura, essendo moduli già rifiniti per l'accostamento.

Open base units, base units with drawers, with big drawers and with doors of various sizes are placed side by side with the washbasin base units to increase the available space and complete the bathroom furniture without the need for a finishing top, as modules are already finished for the combination.

Les éléments ouverts, les éléments bas avec tiroirs, grands tiroirs et avec des portes de différentes tailles sont placés côte à côte avec les éléments bas lavabo pour augmenter l'espace disponible et compléter le mobilier de la salle de bain sans avoir besoin d'un plan de finition, car les éléments bas sont déjà finis pour la combinaison.

Una vasta scelta di moduli chiusi e a giorno

^{EN} A wide choice of closed and open units

^{FR} Un large choix de éléments fermés et ouverts

TOP IDEALCRYL COLORATI LUCIDI E OPACHI

Glossy and matt colored Idealcryl - Top Idealcryl en couleurs brillantes et mates



Alla qualità del materiale che rende i piani top con vasca integrata durevoli nel tempo si affianca la personalizzazione nel colore, un'ampia scelta tra le tonalità della cartella.

Not only are these tops made of a time resistant material, but from now on, they are also available in all the colours of the colour card.

Au-delà du matériel qui rend ces plans résistants dans le temps, maintenant tous les plans en Idealcryl sont aussi disponibles dans tous les coloris de la

Un'ampia gamma di colori per personalizzare il top

^{EN} A wide range of colors to customize the top

^{FR} Une large gamme de couleurs pour personnaliser le plan

NUOVA FINITURA INTERNA

New interior finish - Nouvelle finition intérieure



Oltre alle superfici esterne, anche le parti interne dell'arredo bagno si rivestono di stile con la matericità di una nuova finitura melaminica, Grigio Twist effetto tessuto.

Not only are the outer finishes updated, but also the inner finish is renewed by adopting a melamine similar to a fabric tissue, called Grigio Twist.

Aussi la finition à l'intérieur des meubles vient d'être renouvelée; il s'agit d'une finition mélaminée, Grigio Twist, avec son effet tissu.

Dentro e fuori, l'arredo bagno è curato in ogni dettaglio

^{EN} Inside and out, the bathroom furniture is studied in every detail

^{FR} À l'intérieur comme à l'extérieur, le mobilier de salle de bain est étudié dans les moindres détails

Lavabi Ceramica

Ceramic washbasins - Lavabos en céramique

Ceramica Setup Sp. 7.5



Bianco lucido
Glossy white
Blanc brillant

H. vasca 13
H. sink 13
H. vasque 13

Profondità Depth Profondeur	Vasca centrale Central sink Vasque central	Vasca Dx Rh sink Vasque D	Vasca Sx Lh sink Vasque G
L 41 L 51 L 61 L 71 L 86 L 91 L 96			
P. 35 (40)	L 106		
	L 121		

Ceramica Tube Sp. 13



Bianco lucido
Glossy white
Blanc brillant

H. vasca 10.5
H. sink 10.5
H. vasque 10.5

Profondità Depth Profondeur	Vasca centrale Central sink Vasque central	Vasca Dx Rh sink Vasque D	Vasca Sx Lh sink Vasque G
L 51 L 61 L 71 L 86 L 91 L 96 L 106			
P. 45 (46)	L 121		
L 141			

Ceramica Tony Sp. 9.5



Bianco lucido
Glossy white - Blanc brillant

H. vasca 14
H. sink 14
H. vasque 14

Profondità Depth Profondeur	Vasca centrale Central sink Vasque central	Vasca Dx Rh sink Vasque D	Vasca Sx Lh sink Vasque G
L 73			
P. 35 (38.5)	L 88 L 98 L 108		

Lavabi Ceramica

Ceramic washbasins - Lavabos en céramique

Ceramica Coverslim Sp. 1.6



Bianco lucido
Glossy white
Blanc brillant

H. vasca 13
H. sink 13
H. vasque 13

Profondità Depth Profondeur	Vasca centrale Central sink Vasque central	Vasca Dx Rh sink Vasque D	Vasca Sx Lh sink Vasque G
L 61			
L 71			
P. 45 (46.5)			
L 121			
L 71			
L 86 L 91 L 96			
P. 50 (51.5)			
L 121			

Ceramica Elite Sp. 1.8



Bianco lucido
Glossy white
Blanc brillant

H. vasca 11
H. sink 11
H. vasque 11

Profondità Depth Profondeur	Vasca centrale Central sink Vasque central	Vasca Dx Rh sink Vasque D	Vasca Sx Lh sink Vasque G
L 61.5			
L 71.5			
L 86.5			
L 91.5			
P. 50 (51.5)			
L 106.5			
L 121.5			

Lavabi Idealcryl

Idealcryl washbasins - Lavabos en Idealcryl

Idealcryl Semincasso Sp. 1.2



Profondità Depth Profondeur	Vasca centrale Central sink Vasque central	Vasca Dx Rh sink Vasque D	Vasca Sx Lh sink Vasque G
L 60.5 L 70.5 L 90.5			
P. 35			
L 120.5			

Bianco lucido
Glossy white
Blanc brillant

H. vasca 12.8
H. sink 12.8
H. vasque 12.8

Idealcryl Sp. 1.2



Profondità Depth Profondeur	Foro rubinetto centrale Central robinet hole position Trou central pour mélangeur	Foro rubinetto laterale Hole for lateral robinet Trou pour mélangeur lateral	Foro rubinetto a muro Wall-mounted robinet Robinet à mur
L 60.5 L 70.5 L 90.5			
P. 35			
Con foro miscelatore solo a destra With tap hole only on the right - Avec trou robinet uniquement à droite			
H. vasca 11.5 H. sink 11.5 H. vasque 11.5			

Bianco lucido
Glossy white
Blanc brillant

H. vasca 11.5
H. sink 11.5
H. vasque 11.5

Idealcryl Curvo Sp. 1.2



Profondità Depth Profondeur	Vasca centrale Central sink Vasque central	Vasca Dx Rh sink Vasque D	Vasca Sx Lh sink Vasque G
L 120			
P. 45 (46)			

Bianco lucido e opaco
Glossy white and matt
Blanc brillant et mate

H. vasca 12
H. sink 12
H. vasque 12

Idealcryl Sp. 1.2



Profondità Depth Profondeur	Vasca centrale Central sink Vasque central	Vasca Dx Rh sink Vasque D	Vasca Sx Lh sink Vasque G
L 60.5 L 70.5 L 85.5 L 90.5 L 95.5			
P. 45 (46)			
L 105.5			
L 120.5			

Bianco lucido e opaco
Colore lucido e opaco
Glossy and matt white
Blanc brillant et mat

Colori disponibili a pag.34
Colors available on page 34
Couleurs disponibles à la page 34

H. vasca 12
H. sink 12
H. vasque 12

Lavabi Idealcryl

Idealcryl washbasins - Lavabos en Idealcryl

Idealcryl Sp. 1.2



Disponibile in:
Bianco lucido e opaco
Couleur lustrée et mate

Available in:
Glossy and matt white
Glossy and matte color

Disponible en:
Blanc brillant et mat
Couleur brillante et mate

Colori disponibili a pag.34
Colors available on page 34
Couleurs disponibles à la page 34

H. vasca 12.5
H. sink 12.5
H. vasque 12.5

Profondità Depth Profondeur	Vasca centrale Central sink Vasque central	Vasca Dx Rh sink Vasque D	Vasca Sx Lh sink Vasque G
L 60.5			
L 70.5 L 85.5 L 90.5 L 95.5			
L 105.5			
L 120.5			
P. 50 (50.5)			
L 140.5			

Lavabi Appoggio con top sp.1.8 cm in finitura come la struttura

Countertop washbasins with top th.1.8 cm in the same finish as the structure - Lavabos à poser avec plan d'ép. 1.8 cm dans la même finition que la structure

Circle ø 45 H. 17



Ceramica
Bianco lucido
Ceramic
Glossy white
Céramique
Blanc brillant

Profondità Depth Profondeur	Foro rubinetto centrale Central robinet hole position Trou central pour mélangeur	Foro rubinetto laterale Hole for lateral robinet Trou pour mélangeur lateral	Foro rubinetto a muro Wall-mounted robinet Robinet à mur
P. 35.5			
P. 45.5			
P. 50.5			

Tondo Fine ø 42 H. 13.5

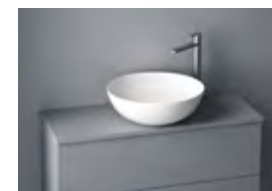

Ceramica
Bianco lucido
Ceramic
Glossy white
Céramique
Blanc brillant

Profondità Depth Profondeur	Foro rubinetto centrale Central robinet hole position Trou central pour mélangeur	Foro rubinetto laterale Hole for lateral robinet Trou pour mélangeur lateral	Foro rubinetto a muro Wall-mounted robinet Robinet à mur
P. 35.5			
P. 45.5			
P. 50.5			

Lavabi Appoggio con top sp.1.8 cm in finitura come la struttura

Countertop washbasins with top th.1.8 cm in the same finish as the structure - Lavabos à poser avec plan d'ép. 1.8 cm dans la même finition que la structure

Softly L 59 x 42 H. 16.5



Profondità Depth Profondeur	Foro rubinetto centrale Central robinet hole position Trou central pour mélangeur	Foro rubinetto laterale Hole for lateral robinet Trou pour mélangeur lateral	Foro rubinetto a muro Wall-mounted robinet Robinet à mur
P. 35.5			
P. 45.5			
P. 50.5			

Ceramica Bianco lucido
Ceramic
Glossy white
Céramique
Blanc brillant

Ovale Gea L 57 x 41.5 H. 12.2



Profondità Depth Profondeur	Foro rubinetto centrale Central robinet hole position Trou central pour mélangeur	Foro rubinetto laterale Hole for lateral robinet Trou pour mélangeur lateral	Foro rubinetto a muro Wall-mounted robinet Robinet à mur
P. 35.5			
P. 45.5			
P. 50.5			

Idealcrl Bianco lucido
Idealcrl
Glossy white
Idealcrl
Blanc brillant

Ovale Fine L 60 x 38.5 H. 14



Profondità Depth Profondeur	Foro rubinetto centrale Central robinet hole position Trou central pour mélangeur	Foro rubinetto laterale Hole for lateral robinet Trou pour mélangeur lateral	Foro rubinetto a muro Wall-mounted robinet Robinet à mur
P. 35.5			
P. 45.5			
P. 50.5			

Ceramica Bianco lucido
Ceramic
Glossy white
Céramique
Blanc brillant

Posizione scarichi su basi

Drain position on washbasin base units - Position écoulement sur éléments bas lavabo

H. 37.5

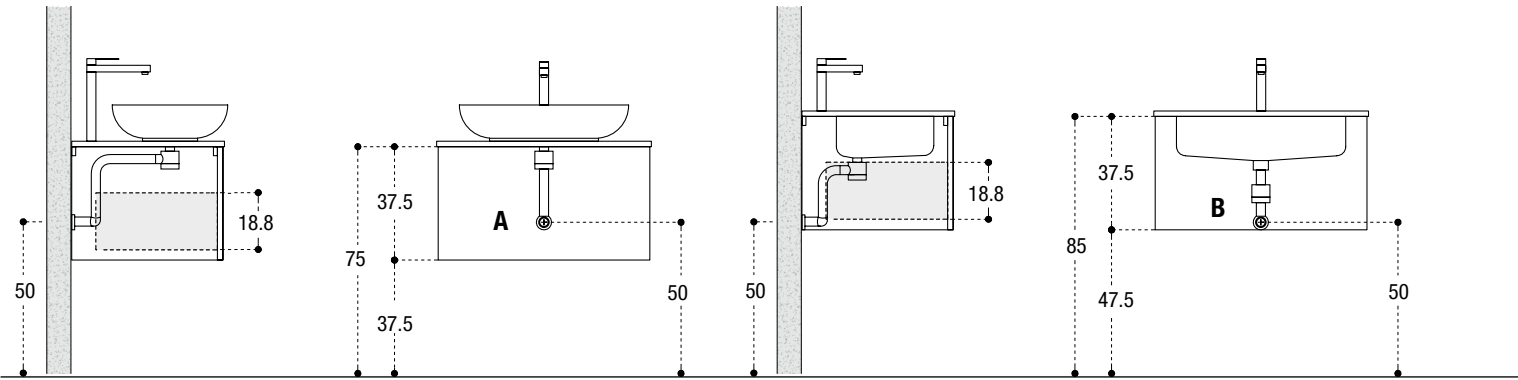

Posizionamento scarichi con cassetto scansato
Drain position on washbasin base units with drawer undertop
Position écoulement sur éléments bas lavabo avec tiroir sous lavabo

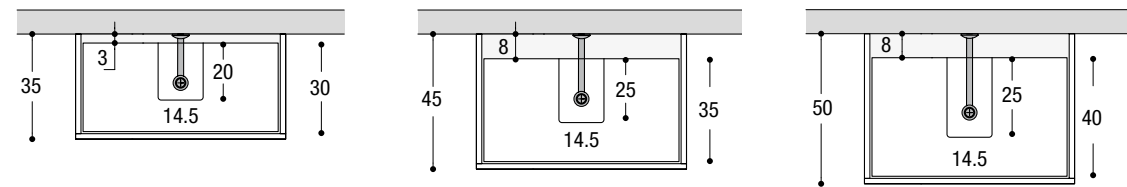

H. 75

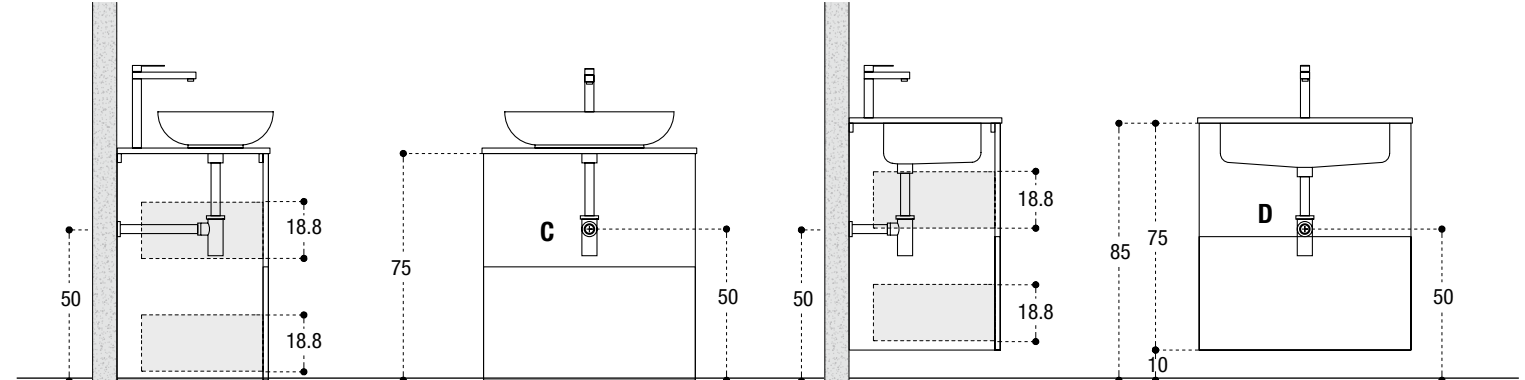

Posizionamento scarichi con cassetto scansato
Drain position on washbasin base units with drawer undertop
Position écoulement sur éléments bas lavabo avec tiroir sous lavabo

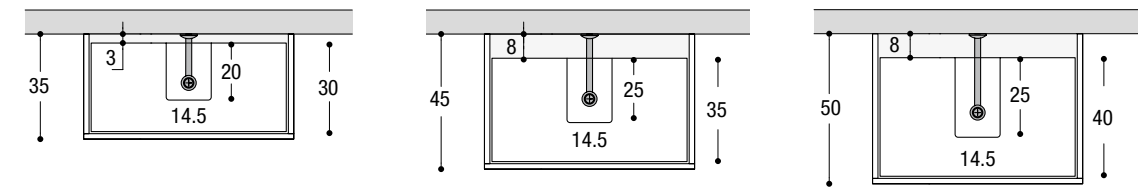

H. 50

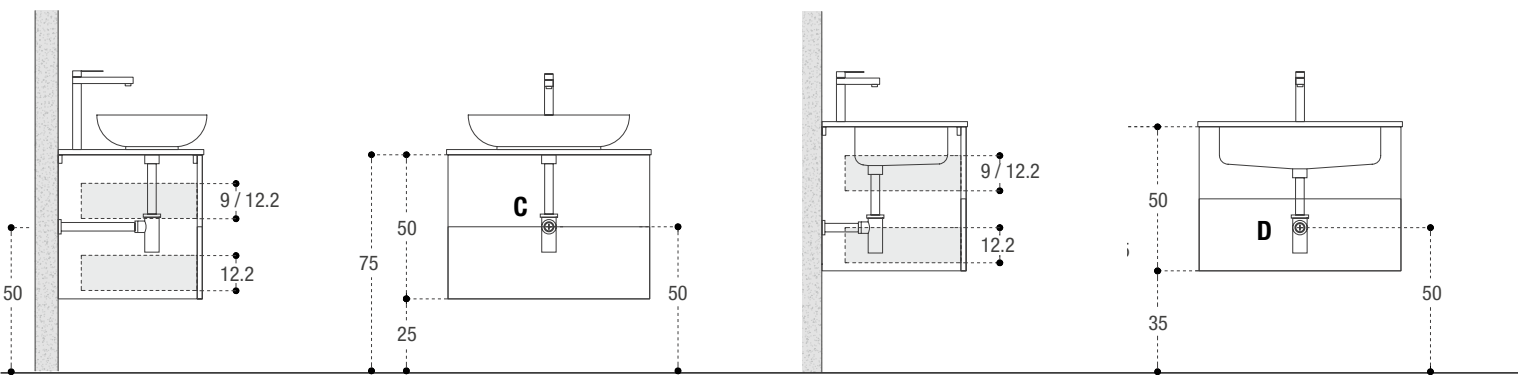

Posizionamento scarichi con cassetto scansato
Drain position on washbasin base units with drawer undertop
Position écoulement sur éléments bas lavabo avec tiroir sous lavabo

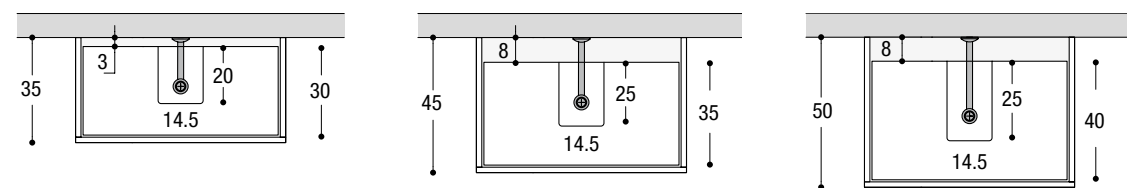

H. 87.5

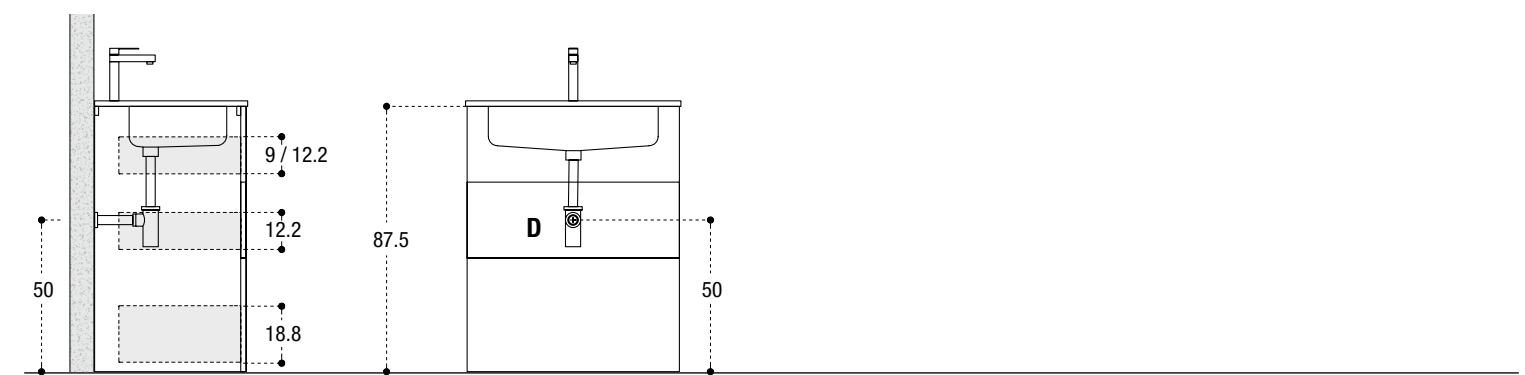

Posizionamento scarichi con cassetto scansato
Drain position on washbasin base units with drawer undertop
Position écoulement sur éléments bas lavabo avec tiroir sous lavabo

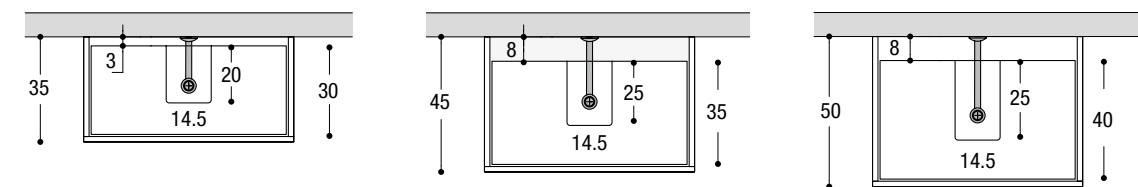

Maniglie

Handles - Poignées

Gola



Abbinamento Gola con basi / colonne
Handles provided according to base units / columns
Poignées à mettre selon la longueur des éléments bas / colonnes

Posizionamento Gola
Gola position
Position Gola

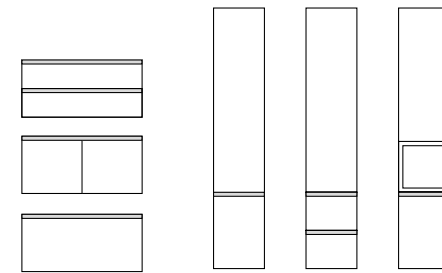

Basi
Base units
Éléments bas

Colonne
Columns
Colonnes



Integrata solo per pensili
Integrated for hanging units only
Intégré uniquement pour armoires murales



Pensili
Hanging units
Armoires murales

Finiture Gola
Gola finishes
Finitions Gola



Maggiorazione cod IOAC210 € 27 cad.
Surcharge cod IOAC210 € 27 cad.
Surprix cod IOAC210 € 27 cad.

Vela



Abbinamento maniglia Vela con basi / pensili / colonne
Vela handle combination with base units / wall units / columns
Combinaison poignée Vela avec éléments bas / éléments hauts / colonnes

La dimensione della maniglia Vela segue la misura dei frontali
The size of the Vela handle follows the size of the fronts
La taille de la poignée Vela suit la taille des façades

Posizionamento maniglia Vela
Vela handle position
Position poignée Vela

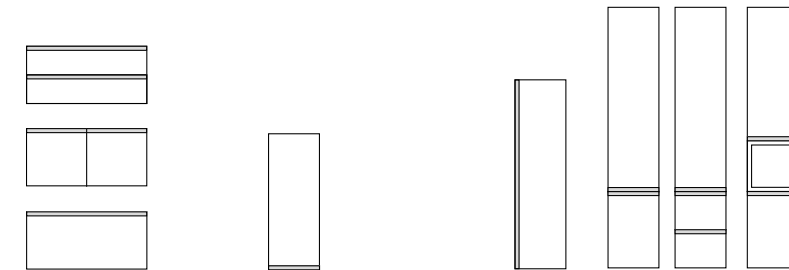

Basi
Base units
Éléments bas

Pensili
Hanging units
Armoires murales

Colonne
Columns
Colonnes

Finiture maniglia
Handle finishes
Finitions Poignée



Maggiorazione cod IOAC211 € 27 cad.
Surcharge cod IOAC211 € 27 cad.
Surprix cod IOAC211 € 27 cad.

Lama



Finiture maniglia
Handle finishes
Finitions Poignée



Maggiorazione cod IOAC198 € 27 cad.
Surcharge cod IOAC198 € 27 cad.
Surprix cod IOAC198 € 27 cad.

Abbinamento maniglia con base / colonna / pensile
Handles provided according to base unit / column / hanging unit width
Poignées à mettre selon la longueur de l'élément bas / colonne / armoire murale

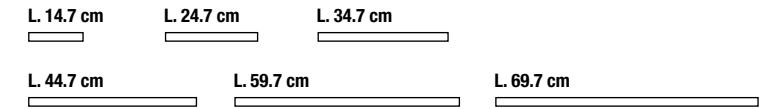

Posizionamento maniglia
Handle position
Position de la poignée

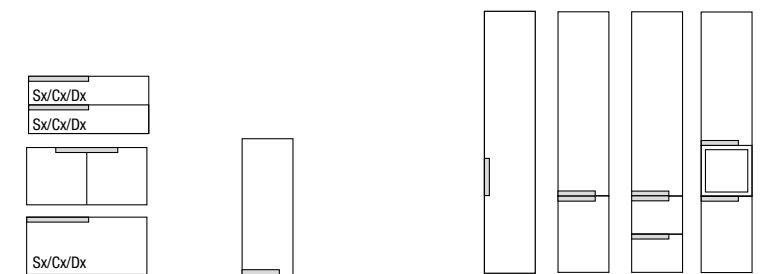

Basi
Base units
Éléments bas

Pensili
Hanging units
Armoires murales

Colonne
Columns
Colonnes

Dot



Finiture maniglia
Handle finishes
Finitions Poignée

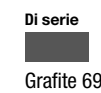

Abbinamento maniglia con base / colonna / pensile
Handles provided according to base unit / column / hanging unit width
Poignées à mettre selon la longueur de l'élément bas / colonne / armoire murale

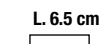

Posizionamento maniglia
Handle position
Position de la poignée

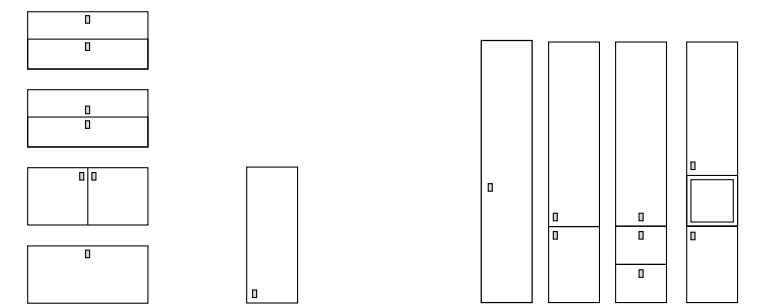

Basi
Base units
Éléments bas

Pensili
Hanging units
Armoires murales

Colonne
Columns
Colonnes

Ponte



Abbinamento maniglia con base / colonna / pensile
 Handles provided according to base unit / column / hanging unit width
 Poignées à mettre selon la longueur de l'élément bas / colonne / armoire murale

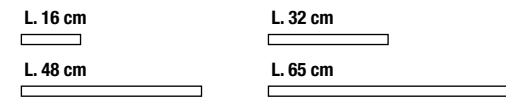

Posizionamento maniglia
 Handle position
 Position de la poignée

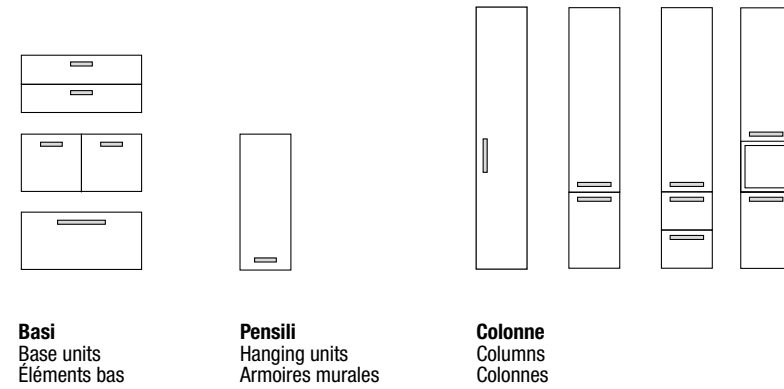

Finiture maniglia
 Handle finishes
 Finitions Poignée

Di serie
 Brill

Astra



Abbinamento maniglia con base / colonna / pensile
 Handles provided according to base unit / column / hanging unit width
 Poignées à mettre selon la longueur de l'élément bas / colonne / armoire murale



Posizionamento maniglia
 Handle position
 Position de la poignée

Finiture maniglia
 Handle finishes
 Finitions Poignée

Di serie
 Grafite 69
 Acciaio spazzolato

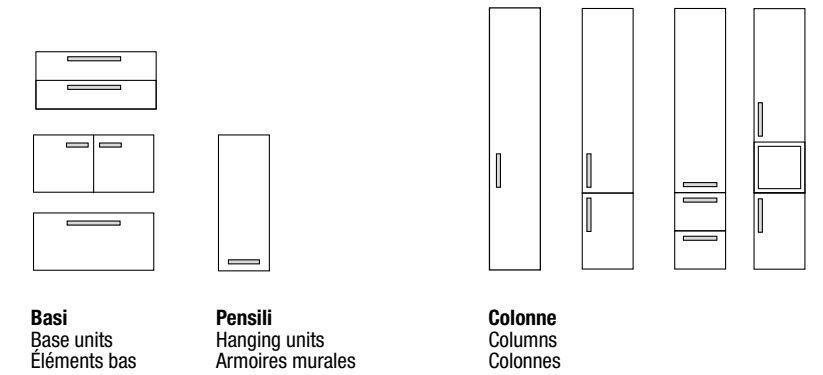

Ponte curvo



Abbinamento maniglia con base
 Handles provided according to base unit
 Poignées à mettre selon la longueur de l'élément bas

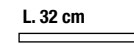

Posizionamento maniglia
 Handle position
 Position de la poignée

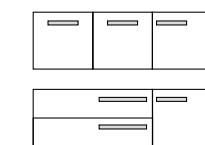

Basi
 Base units
 Éléments bas

Solo per basi curve
 For curved bases only
 Uniquement pour les éléments bas courbes

Finiture maniglia
 Handle finishes
 Finitions Poignée

Di serie
 Brill

Push&Pull



Abbinamento maniglia con basi accosto e colonne
 Handle combination with base units and columns
 Combinaison de poignées avec éléments bas et colonnes

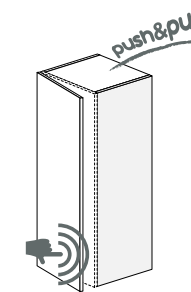

Sistema Push&Pull solo per colonne, pensili e basi accosto con anta
 Push & pull system only for columns, hanging units and base units
 Système push & pull uniquement pour colonnes, armoires murales et éléments bas

Modularità

Modularity - Modularité



Base lavabo
Washbasin base units
Éléments bas lavabo

Basi Lavabo

Washbasin base units - Éléments bas lavabo

H_{cm} **37.5**

P_{cm} **35 - 45 - 50**

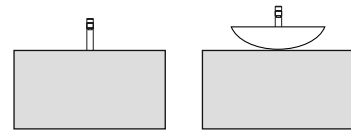

Per tutti i lavabi
For all washbasins - Pour tous les lavabos

H_{cm} **50**

P_{cm} **35 - 45 - 50**

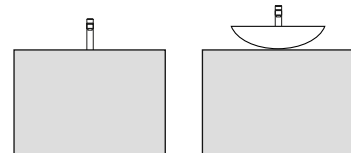

Per tutti i lavabi
For all washbasins - Pour tous les lavabos

H_{cm} **75**

P_{cm} **35 - 45 - 50**

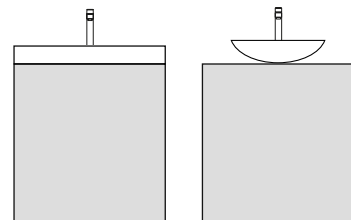

Per tutti lavabi appoggio e consolle:
For all countertop washbasins and consoles - Pour tous les lavabos à poser et consoles :
Setup - Tube - Tony

H_{cm} **87.5**

P_{cm} **35 - 45 - 50**

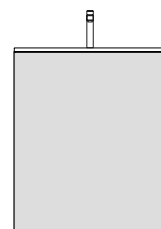

Per lavabi:
For washbasins - Pour les lavabos
Idealcryn - Coverslim - Semincasso - Elite

Configurazioni: cassettoni / cassetti / ante

Configurations: big drawers / drawers / doors - Configurations : grands tiroirs / tiroirs / portes

H_{cm} **37.5**



L. 40-50-60-70-85-90-95-105-120
1 cassettone
1 big drawer
1 grand tiroir

L. 95
2 cassettoni
2 big drawers
2 grands tiroirs

L. 105
2 cassettoni
2 big drawers
2 grands tiroirs

L. 120
2 cassettoni
2 big drawers
2 grands tiroirs

L. 120
2 cassettoni
2 big drawers
2 grands tiroirs
***solo doppio lavabo**
only double sink
uniquement double vasque

L. 140
2 cassettoni
2 big drawers
2 grands tiroirs
***solo doppio lavabo**
only double sink
uniquement double vasque

H_{cm} **50**

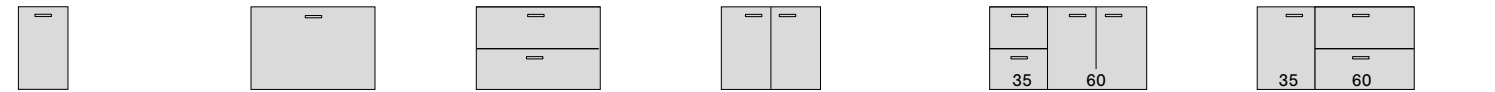

L. 40-50
1 anta
1 door
1 porte

L. 60-70-90-95
1 cassettone
1 big drawer
1 grand tiroir

L. 40-50-60-70-85-90-95-105-120
2 cassetti
2 drawers
2 tiroirs

L. 60-70-85-90
2 ante
2 doors
2 portes

L. 95
2 cassetti / 2 ante
2 drawers / 2 doors
2 tiroirs / 2 portes

L. 95
1 anta / 2 cassetti
1 door / 2 drawers
1 porte / 2 tiroirs

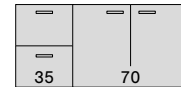

L. 105
2 cassetti / 2 ante
2 drawers / 2 doors
2 tiroirs / 2 portes

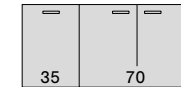

L. 105
3 ante
3 doors
3 portes

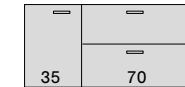

L. 105
1 anta / 2 cassetti
1 door / 2 drawers
1 porte / 2 tiroirs

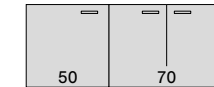

L. 120
3 ante
3 doors
3 portes

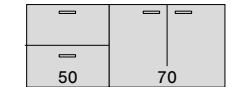

L. 120
2 cassetti / 2 ante
2 drawers / 2 doors
2 tiroirs / 2 portes

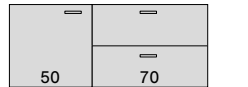

L. 120
1 anta / 2 cassetti
1 door / 2 drawers
1 porte / 2 tiroirs

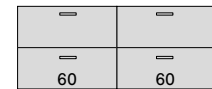

L. 120
4 cassetti
4 drawers
4 tiroirs
***solo doppio lavabo**
only double sink
uniquement double vasque

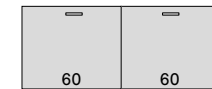

L. 120
2 cassettoni
2 big drawers
2 grands tiroirs
***solo doppio lavabo**
only double sink
uniquement double vasque

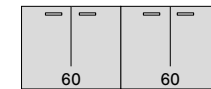

L. 120
4 ante
4 doors
4 portes
***solo doppio lavabo**
only double sink
uniquement double vasque

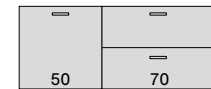

L. 120
1 cassettone / 2 cassetti
1 big drawer / 2 drawers
1 grand tiroir / 2 tiroirs

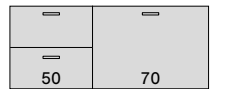

L. 120
2 cassetti / 1 cassettone
2 drawers / 1 big drawer
2 tiroirs / 1 grand tiroir



L. 140
4 cassetti
4 drawers
4 tiroirs
***solo doppio lavabo**
only double sink
uniquement double vasque

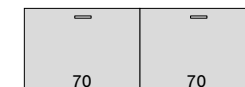

L. 140
2 cassettoni
2 big drawers
2 grands tiroirs
***solo doppio lavabo**
only double sink
uniquement double vasque



L. 140
4 ante
4 doors
4 portes
***solo doppio lavabo**
only double sink
uniquement double vasque



L. 120
1 anta / 2 cassetti
1 door / 2 drawers
1 porte / 2 tiroirs



L. 120
3 ante
3 doors
3 portes
***base curva**
curved bases
éléments bas courbes

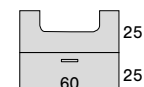

L. 60-70-90
1 fisso / 1 cassetto
1 fixed / 1 drawer
1 fixe / 1 tiroir

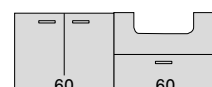

L. 120
1 fisso / 2 ante / 1 cassetto
1 fixed / 2 doors / 1 drawer
1 fixe / 2 portes / 1 tiroir



L. 120
3 cassetti / 1 fisso
3 drawers / 1 fixed
3 tiroirs / 1 fixe

H_{cm} 75

L. 60-70-85-90 2 ante 2 doors 2 portes	L. 60-70-85-90 95-105-120 2 cassetti 2 drawers 2 tiroirs	L. 90 3 ante 3 doors 3 portes	L. 90 2 ante / 2 cassettoni 2 drawers / 2 big drawers 2 tiroirs / 2 grands tiroirs	L. 95 2 cassetti / 2 ante 2 drawers / 2 doors 2 tiroirs / 2 portes	L. 95 1 ante / 2 cassetti 1 door / 2 drawers 1 porte / 2 tiroirs	L. 105 2 cassetti / 2 ante 2 drawers / 2 doors 2 tiroirs / 2 portes

L. 105 3 ante 3 doors 3 portes	L. 105 1 ante / 2 cassetti 1 door / 2 drawers 1 porte / 2 tiroirs	L. 120 2 cassetti / 2 ante 2 drawers / 2 doors 2 tiroirs / 2 portes	L. 120 1 ante / 2 cassetti 1 door / 2 drawers 1 porte / 2 tiroirs	L. 120 3 ante 3 doors 3 portes

L. 120* 4 cassetti 4 drawers 4 tiroirs	L. 120* 4 ante 4 doors 4 portes	L. 140* 4 cassetti 4 drawers 4 tiroirs	L. 140* 4 ante 4 doors 4 portes

* Solo doppio lavabo
* only double sink -
* uniquement double vasque

H_{cm} 87.5

L. 60-70 85-90 2 ante 2 doors 2 portes	L. 60-70-85-90 95-105-120 2 cassettoni 2 big drawers 2 grands tiroirs	L. 70-85-90-95 105-120 2 cassetti / 1 cassettone 2 drawers / 1 big drawer 2 tiroirs / 1 grand tiroir	L. 105-120 3 ante 3 doors 3 portes	L. 105-120 2 cassetti / 2 ante 2 drawers / 2 doors 2 tiroirs / 2 portes	L. 105-120 1 ante / 2 cassettoni 1 door / 2 big drawers 1 porte / 2 grands tiroirs	L. 120-140* 4 cassetti 4 drawers 4 tiroirs

L. 120-140* 4 ante 4 doors 4 portes	L. 60-70 90-120 1 fisso / 1 cassetto 1 cassettone 1 fixed / 1 drawer / 1 big drawer 1 fixe / 1 tiroir / 1 grand tiroir	L. 60-70-90 1 fisso / 2 ante 1 fixed / 2 doors 1 fixe / 2 portes	L. 90 1 fisso / 3 ante 1 fixed / 3 doors 1 fixe / 3 portes	L. 90-120 1 fisso / 2 cassetti / 2 ante 1 fixed / 2 drawers / 2 doors 1 fixe / 2 tiroirs / 2 portes	L. 120 1 fisso / 1 ante / 2 cassetti 1 fixed / 1 door / 2 drawers 1 fixe / 1 porte / 2 tiroirs	L. 120 1 fisso / 2 cassetti / 2 ante 1 fixed / 2 drawers / 2 doors 1 fixe / 2 tiroirs / 2 portes

* Solo doppio lavabo
* only double sink -
* uniquement double vasque

Modularità

Modularity - Modularité

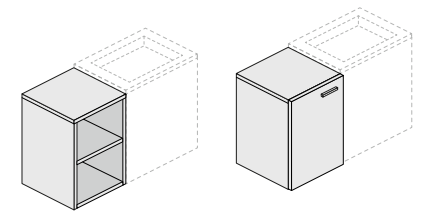

Vano a giorno
Open compartment
Compartiments ouvert

Base accosto
Base unit
Élément bas

Basi accosto con lato superiore in tinta

Base units with matching upper side - Éléments bas avec dessus assorti

H_{cm} 37.5

Vano a giorno Open compartment Compartiments ouvert	Anta Door / Porte	Cassettone Big drawer / Grand tiroir
L cm 30 - 45		
P cm 35 - 45 - 50		

H_{cm} 50

Vano a giorno Open compartment Compartiments ouvert	Anta Door / Porte	Cassettoni Big drawers / Grand tiroirs	Cassettone / cassetto interno Big drawer, 1 internal drawer Grand tiroir, 1 tiroir interne
L cm 30 - 45			
P cm 35 - 45 - 50			

H_{cm} 75

Vano a giorno Open compartment Compartiments ouvert	Anta Door / Porte	Cassettoni Big drawers / Grand tiroirs
L cm 30 - 45		
P cm 35 - 45 - 50		

H_{cm} 87.5

Anta Door / Porte	Cassettoni Big drawers / Grand tiroirs	Cassetti / Cassettone Drawers - Big drawers Tiroirs - Grand tiroirs	Cassetto / Anta Drawer - Door Tiroir - Porte
L cm 30 - 45			
P cm 35 - 45 - 50			

Maniglie

Handles
Poignées

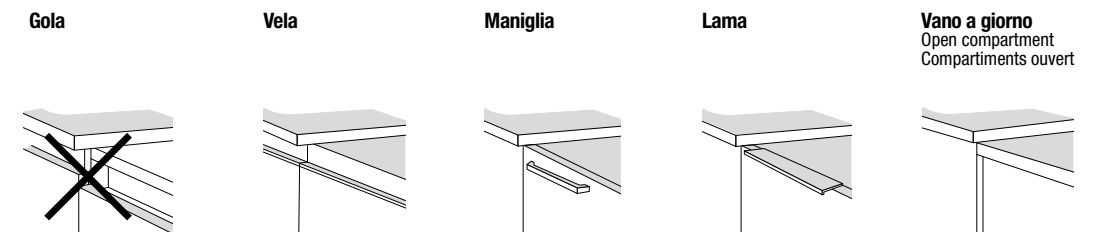

* Non disponibile
Not available - Non disponible

Finiture e colori

Finishes and colours - Finitions et couleurs

Melaminici

Melamine - Mélaminés



* Per strutture e frontali e top
For structures, fronts and tops
Pour structures, façades et plans

Laccati opachi / lucidi

Matt laquers - Laques mates



* Per strutture e frontali e top
For structures, fronts and tops
Pour structures, façades et plans

Top Idealcolor con vasca integrata colore opaco / lucido

Top with integrated sink - Plan avec vasque moulée



* Tutti i colori Idealcolor tranne:
All Idealcolor colors except:
Toutes les couleurs Idealcolor sauf:



10 Nero



47 Rame
Metallizzato



48 Ottone
Metallizzato



49 Acciaio
Metallizzato



50 Titanio
Metallizzato

profondità
35

depth - profondeur

Tutta la forza del design anche in piccoli spazi

All the strenght of the design
in little spaces too

Toute la force du design même
dans les petits espaces

Lavabi Ceramica Ceramic - Céramique



Ceramica Setup



Ceramica Tony

Lavabi Idealcryl



Idealcryl Bianco
White - Blanc



Idealcryl Semincasso
Semi recessed - Semi-encasté

Lavabi Appoggio con top in finitura come la struttura

Countertop washbasins with top in the same finish as the structure - Lavabos à poser avec plan dans la même finition que la structure



Softly



Ovale Gea



Ovale Fine



Circle



Tondo Fine

Comp.501

L'essenzialità dell'arredo con un tocco di colore

The essentiality of the furniture with a touch of color
L'essentialité du meuble avec une touche de couleur

L.120 P35 H50_ Melaminico Nodato Bianco

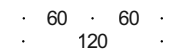
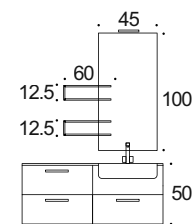

Base lavabo Melaminico Nodato Bianco
Maniglia ASTRA Acciaio spazzolato
Top Idealcyl semincasso Bianco lucido
Mensole Laccato Zafferano opaco
Specchiera BASIC telaio Alluminio spazzolato
Lampada NICE Cromo



Base lavabo Melaminico Nodato Creta
Maniglia GOLA Nero opaco
Lavabo OVALE GEA lucido
Top Melaminico Nodato Creta
Mensole Laccato Nero opaco
Specchiera STRIP con Led

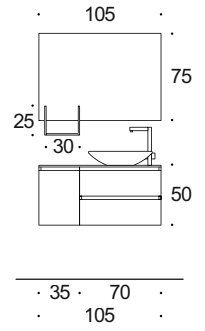

L105 P35 H50_ Melaminico Nodato Creta

Comp.502

**La gola disegna
 linee intere o parziali**

The GOLA draws whole or partial lines
 La prise de main GOLA dessine des lignes
 entières ou partielles



Base lavabo Melaminico Alpaca
 Maniglia VELA Laccato Piombo opaco
 Top SETUP lucido
 Mensola Melaminico Tortora
 Specchiera BASIC Telaio Nero
 Lampada NICE Nera



Comp.503

**La praticità e lo stile
 del lavabo a tutta lunghezza**

The practicality and style of the full-length washbasin
 La praticité et le style du lavabo de pleine longueur

L90 P35 H50_ Melaminico Alpaca

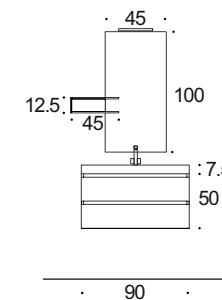

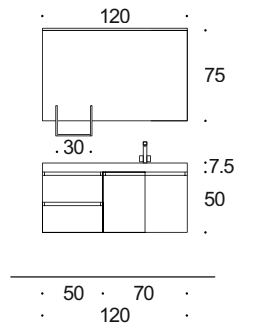

L.120 P35 H50_ Melaminico Rovere Gessato

Comp.504

**La modernità del colore
sulla maniglia e sulla mensola**

The modernity of color on the handle and shelf
La modernité de la couleur sur la poignée et l'étagère



Base lavabo Melaminico Rovere Gessato
Maniglia VELA Laccato Verde Nevada opaco
Top SETUP lucido
Mensole Laccato Verde Nevada opaco
Specchiere BASIC telaio Alluminio spazzolato
Lampada PLEA

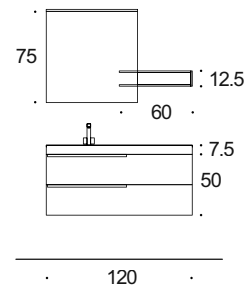

L120 P35 H50_ Laccato Azzuro Fata opaco

Comp.505

I toni dell'azzurro per un bagno leggero

The shades of blue for a light bathroom
Les nuances de l'azur pour une salle de bain légère



Base lavabo Laccato Azzuro Fata opaco
Maniglia LAMA Laccato Azzuro Fata opaco
Top SETUP lucido
Mensole Laccato Azzuro Fata opaco
Specchiera BASIC Filo lucido
Lampada FLY

Comp.506

Una soluzione salvaspazio in cui c'è tutto

A space-saving solution in which there is everything
Une solution sauve-espace dans laquelle il y a tout

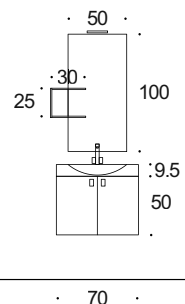

L70 P35 H50_ Melaminico Vulcano



Base lavabo Melaminico Vulcano
Maniglia DOT Grafite
Top TONY lucido
Mensola Melaminico Vulcano
Specchiera BASIC Filo lucido
Lampada NICE Nera

Base lavabo Melaminico Frassino Bianco
Maniglia GOLA Laccato Efeso opaco
Top TONY lucido
Mensole Laccato Efeso opaco
Specchiera ROT con Led



Comp.507

Una base a terra compatta e capiente allo stesso tempo

A floor-standing base unit that is compact and capacious at the same time
Un élément bas posé au sol compact et spacieux à la fois

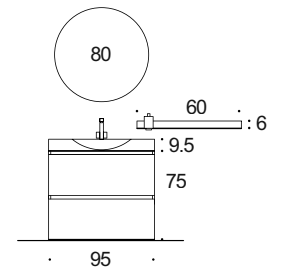

L95 P35 H75_ Melaminico Frassino Bianco

Comp.508

La sintesi perfetta di funzionalità e stile

The perfect synthesis of functionality and style
La synthèse parfaite de fonctionnalité et de style



Base lavabo Melaminico Piuma
Maniglia VELA Grigio Polvere opaco
Top SETUP lucido
Mensole Melaminico Noce Canaletto
Specchiera BASIC telaio Alluminio spazzolato
Lampada PLEA
Pensile Melaminico Piuma

L120 P35 H75_ Melaminico Piuma

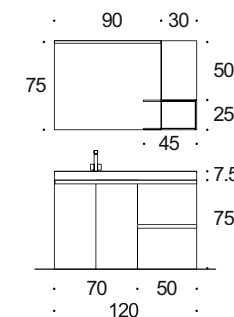

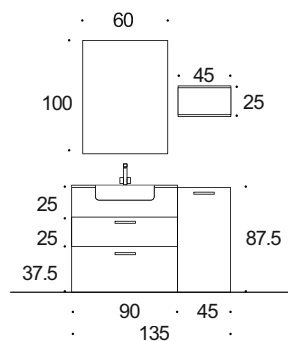

L135 P35 H87.5_Melaminico Rasato Bianco

Comp.509

L'eleganza di un delicato effetto rasato

The elegance of a delicate material effect
L'élégance d'un effet texturé délicat



Base lavabo Melaminico Rasato Bianco
Maniglia ASTRA Grafite
Top Idealcryl semincasso lucido
Mensole Laccato Nero opaco
+ schienale Melaminico Rasato Bianco
Specchiera FRAME Nera con Led



Base lavabo Melaminico Rovere Cognac
 Maniglia DOT Grafite
 Top Idealcryn lucido
 Mensola Laccato Bianco opaco
 + schienale Melaminico Rovere Cognac
 Specchiera BASIC Filo lucido

Comp.510

L'arredo perfetto per portare stile in poco spazio

The perfect furniture to bring style in a small space
 Le meuble parfait pour apporter du style dans un petit espace

L90 P35 H37.5_ Melaminico Rovere Cognac

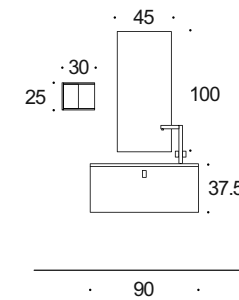

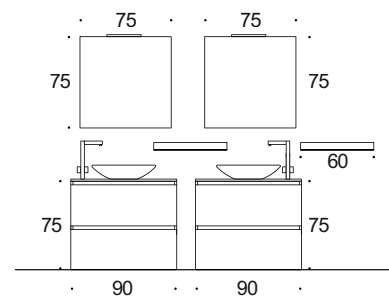

L90 + 90 P35 H75_ Melaminico Patagonia Grey

Comp.511

I toni scuri dell'effetto marmo danno personalità

The dark tones of the marble effect give it personality
Les tons sombres de l'effet marbre donnent lui de la personnalité



Base lavabo Melaminico Patagonia Grey
Maniglia VELA Laccato Piombo opaco
Top Patagonia Grey
Lavabo OVALE FINE lucido
Mensole Laccato Piombo opaco
Specchiera BASIC telaio Nero
Lampade NICE

profondità

45

depth - profondeur

Più in profondità nella scelta dell'arredo bagno

More accurate in the choice of the bathroom furniture

Plus en profondeur pour le choix du mobilier de la salle de bain

Lavabi Ceramica Ceramic - Céramique



Ceramica Tube



Ceramica Coverslim

Lavabi Idealcryl



Idealcryl Bianco
Idealcryl White - Idealcryl Blanc



Idealcryl Colore
Idealcryl Color - Idealcryl Couleur



Idealcryl Curvo
Curved Idealcryl - Idealcryl Courbe

Lavabi Appoggio con top in finitura come la struttura

Countertop washbasins with top in the same finish as the structure - Lavabos à poser avec plan dans la même finition que la structure



Softly



Ovale Gea



Ovale Fine



Circle



Tondo Fine

Base lavabo Melaminico Dogato
Maniglia VELA Laccato Ottone metallizzato
Lavabo SOFTLY lucido
Top Melaminico Dogato
Mensole Laccato Ottone metallizzato
Specchiera ROT con Led



Comp.512

Il leggero rilievo della finitura riveste un bagno raffinato

The slight relief of the finish covers a refined bathroom
Le léger relief de la finition recouvre une salle de bain raffinée

L90 P45 H50_ Melaminico Dogato

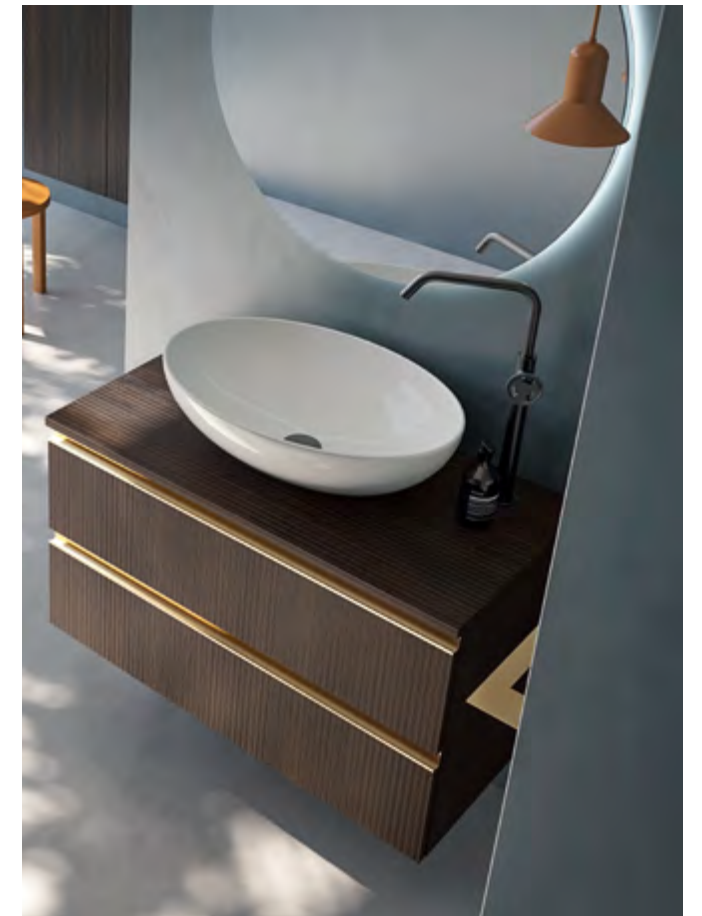
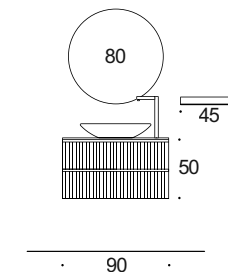

Comp.513

**La naturalezza del legno
scalda l'arredo e l'ambiente**

The naturalness of wood warms the bathroom
La naturalité du bois réchauffe la salle de bain

L135 P45 H75_ Melaminico Rovere Nodato

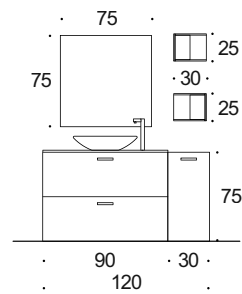

Base lavabo Melaminico Rovere Nodato
Maniglia ASTRA Acciaio spazzolato
Lavabo OVALE FINE lucido
Top Melaminico Rovere Nodato
Mensole Laccato Grigio Berlino opaco
+ schienale Melaminico Rovere Nodato
Specchiera STRIP con Led



Base lavabo Melaminico Rasato Malta
Maniglia LAMA Laccato Tamigi opaco
Lavabo TUBE
Mensole Laccato Grigio Tamigi opaco
+ schienale Melaminico Rasato Malta
Specchiera BASIC filo lucido



Comp.514

L'effetto malta riveste un bagno di tendenza

The material effect covers a trendy bathroom
L'effet matérique recouvre une salle de bain à la mode

L105 P45 H75_ Melaminico Rasato Malta

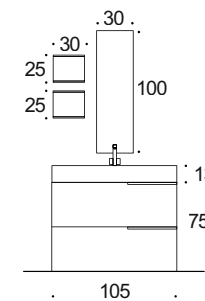



Base lavabo Laccato Oceano opaco
Maniglia GOLA Laccato Salvia opaco
Top Idealcryl colore Oceano opaco
Mensole CLOCK Laccato Oceano opaco
Specchiera STRIP con Led

Comp.515

**Un colore moderno e sofisticato
 risalta le forme lineari**

A modern and sophisticated color highlights the linear shapes
 Une couleur moderne et sophistiquée met en valeur les formes linéaires

L90 P45 H37.5_ Laccato Oceano opaco

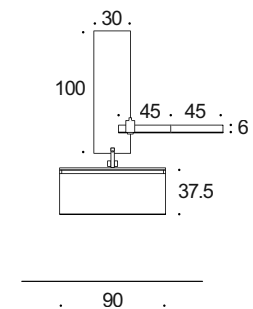

Comp.516

Il lavabo segue l'andamento fluido dell'arredo

The washbasin follows the fluid trend of the furniture
Le lavabo suit la tendance fluide du meuble

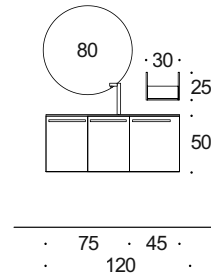

L120 P45 H50_ Laccato Verde Nevada opaco



Base lavabo Laccato Verde Nevada opaco
 Maniglia PONTE Brill
 Top Idealcristal curvo lucido
 Mensola Laccato Nero opaco
 Specchiera ROT con Led



Base lavabo Laccato Bianco opaco
 Maniglia PONTE Brill
 Top Idealcrl curvo lucido
 Mensole Laccato Camomilla opaco
 Specchiera BASIC telaio Cromo

Comp.517

**Linee morbide e geometrie
 per una composizione armoniosa**

Soft and geometric lines for a harmonious composition
 Des lignes douces et géométriques pour une composition harmonieuse

L.120 P.45 H.50_ Laccato Bianco opaco

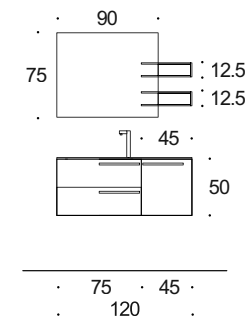



Basi lavabo Laccato Marsala opaco + Rosa Quarzo opaco
 Maniglie LAMA Laccato Marsala opaco + Rosa Quarzo opaco
 Top Idealcryn colore Marsala opaco + Rosa Quarzo opaco
 Mensole Laccato Marsala opaco + Rosa Quarzo opaco
 Specchiera STRIP con Led

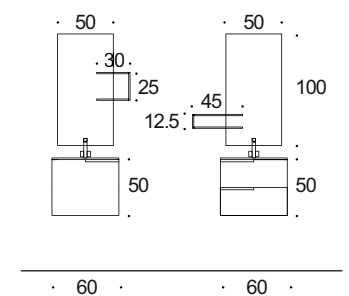
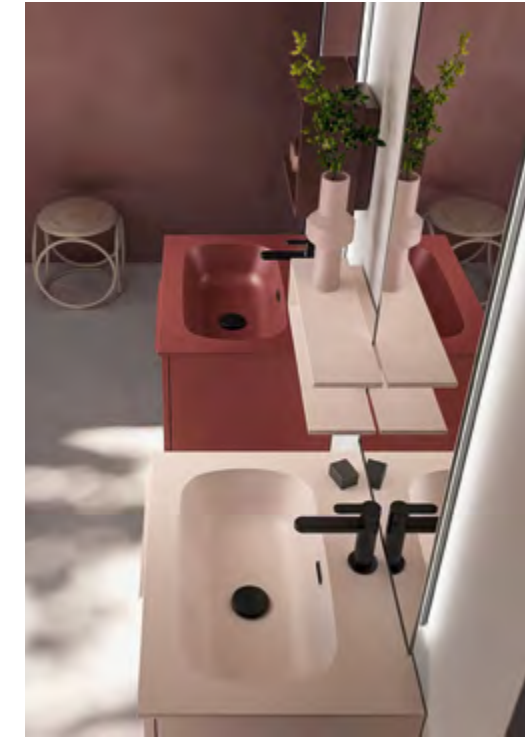

L60 + 60 P45 H50_ Laccato Marsala opaco + Rosa Quarzo opaco

Comp.518

**La coppia di basi
 raddoppia praticità e stile**

The pair of base units doubles practicality and style
 La paire des éléments bas double praticité et style



Basi lavabo Melaminico Rovere Nodato
 Maniglie ASTRA grafite
 Top TUBE lucido
 Vano a Giorno Laccato Titanio metallizzato
 Mensole Laccato Titanio metallizzato
 Specchiera ROT con Led

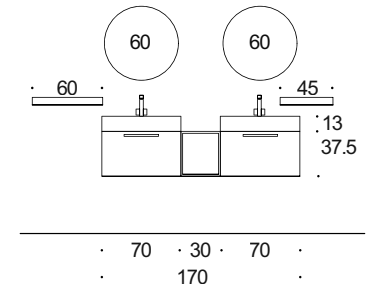

L170 P45 H37.5_ Melaminico Rovere Nodato

Comp.519

**Un bagno per due
 in un unico ambiente**

A bathroom for two in one room
 Une salle de bain pour deux dans un seul espace





Base lavabo Melaminico Piasentina
 Maniglia VELA Laccato Ottone metallizzato
 Top Idealcristal lucido
 Mensole Laccato Ottone metallizzato
 Specchiera BASIC telaio Alluminio spazzolato
 Pensili Laccato Ottone metallizzato

Comp.520

La purezza tattile e visiva della pietra

The tactile and visual purity of the stone
 La pureté tactile et visuelle de la pierre

L.120 P.45 H.50_ Melaminico Piasentina

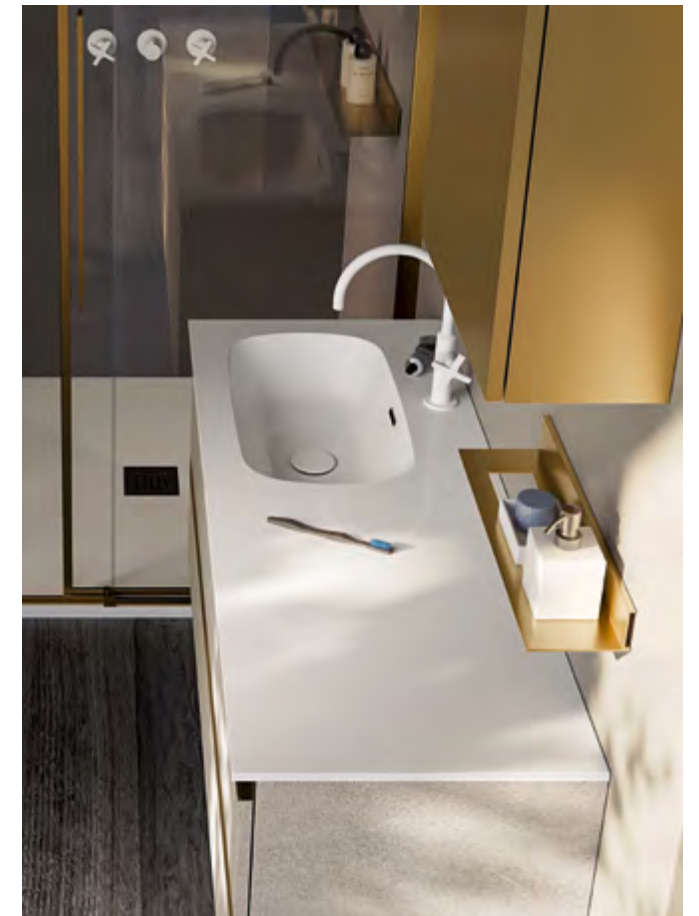
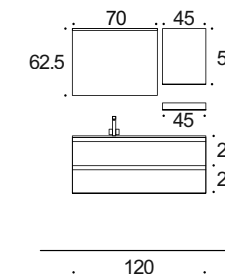



Base lavabo Melaminico Noce Canaletto
 Maniglia ASTRA Grafite
 Top COVERSLIM lucido
 Mensole Laccato Bianco opaco
 + schienale Noce Canaletto
 Specchiera STRIP con Led

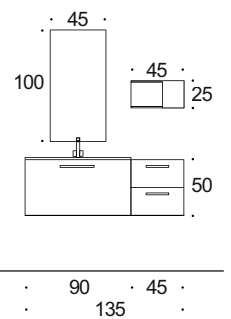

L135 P45 H50_ Melaminico Noce Canaletto

Comp.521

Il calore delle venature per un bagno accogliente e naturale

The warmth of the veins for a welcoming and natural bathroom
 La chaleur des veines pour une salle de bain chaleureuse et naturelle

Comp.522

La luminosità dell'effetto marmo amplifica lo spazio

The brightness of the marble effect amplifies the space
La luminosité de l'effet marbre amplifie l'espace

L140 P45 H50_ Melaminico Calacatta

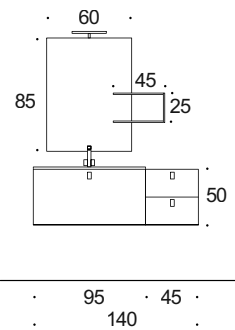

Base lavabo Melaminico Calacatta
 Maniglia DOT Grafite
 Top Idealcryn opaco
 Mensola Laccato Titanio metallizzato
 + schienale Melaminico Calacatta
 Specchiera BASIC telaio Nero
 Lampada COMETA Nera

profondità
50

depth - profondeur

L'unicità del design con una maggiore profondità

Uniqueness of design with more depth

Caractère unique du design avec une plus grande profondeur

Lavabi Ceramica Ceramic - Céramique



Ceramica Elite



Ceramica Coverslim

Lavabi Idealcryl



Idealcryl Bianco
Idealcryl White - Idealcryl Blanc



Idealcryl Colore
Idealcryl Color - Idealcryl Couleur

Lavabi Appoggio con top in finitura come la struttura

Countertop washbasins with top in the same finish as the structure - Lavabos à poser avec plan dans la même finition que la structure



Softly



Ovale Gea



Ovale Fine



Circle



Tondo Fine

Comp.523

Tanto spazio con pochi elementi indispensabili

Plenty of space with just a few essential elements
Beaucoup d'espace avec seulement quelques éléments essentiels

L120 P50 H50_ Melaminico Patagonia Grey

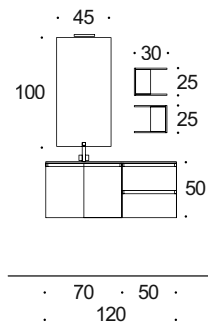

Base lavabo Melaminico Patagonia Grey
Maniglia VELA Laccato Efeso opaco
Top Idealcryn colore Efeso opaco
Mensole Laccato Efeso opaco
 + schienale Melaminico Patagonia Grey
Specchiera BASIC Filo Lucido
Lampada NICE Cromo



Base lavabo Laccato Terracotta opaco
 Maniglia LAMA Terracotta opaco
 Top Idealcryl colore Terracotta opaco
 Mensole Laccato Verde Nevada opaco
 Specchiera STRIP con Led

Comp.524

Base, top e maniglia in tinta unita per un bagno moderno

Base unit, top and handle in solid color for a modern bathroom
 Élément bas, plan et poignée de couleur unie pour une salle de bain moderne

L120 P50 H50_ Laccato Terracotta opaco

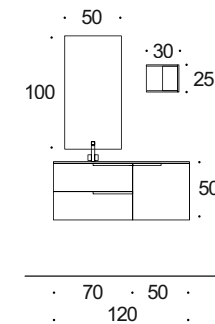

Base lavabo Melaminico Rasato Malta
 Maniglia GOLA Laccato Oceano opaco
 Top Idealcryn colore Oceano opaco
 Mensola Laccato Oceano opaco
 Specchiera BASIC con bordo Nero
 Lampada PLEA
 Pensile Melaminico Rasato Malta

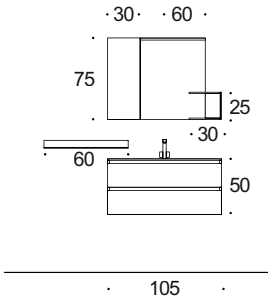

L105 P50 H50_ Melaminico Rasato Malta

Comp.525

Un mix di geometrie ed elementi per un bagno completo

A mix of geometries and elements for a complete bathroom
 Un mélange de géométries et d'éléments pour une salle de bain complète





Base lavabo Melaminico Tortora
 Maniglia LAMA Brill
 Top COVERSLIM lucido
 Mensole Laccato Castoro opaco
 Specchiera BASIC telaio Alluminio spazzolato
 Lampada NICE Cromo

Comp.526

Piccole dimensioni ma grande contenimento

Small size but great storage
 Petite taille mais bon rangement

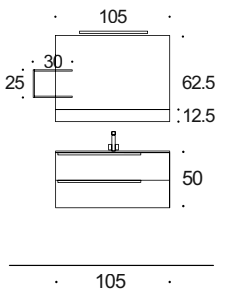

L120 P50 H50_ Melaminico Tortora



Base lavabo Melaminico Frassino Bianco
 Maniglia LAMA Laccato Titanio metallizzato
 Top Idealcryl bianco lucido
 Mensole Laccato Titanio metallizzato
 Specchiera STRIP con Led

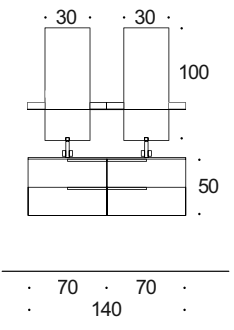

L.140 P.50 H.50_ Melaminico Frassino Bianco

Comp.527

**Con il doppio lavabo
 ognuno ha il proprio spazio**

With the double sink everyone has their own space
 Avec le double lavabo, chacun a son espace



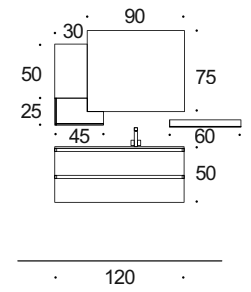

L120 P50 H50_ Melaminico Frassino Naturale

Comp.528

Un arredo lineare per uno stile naturale

Un décor linéaire pour un style naturel
A linear furniture for a natural style



Base lavabo Melaminico Frassino Naturale
Maniglia GOLA Laccato Cappuccino opaco
Top Idealcyl Bianco lucido
Mensola Melaminico Piuma + Laccato Efeso opaco
Specchiera BASIC Filo lucido
Pensile Melaminico Piuma

Comp.529

La texture del legno abbinata all'eleganza del grigio

The texture of wood combined with the elegance of gray
La texture du bois alliée à l'élégance du gris

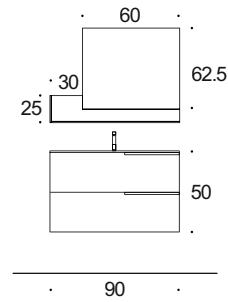

L90 P50 H50_ Melaminico Noce Canaletto



Base lavabo Melaminico Noce Canaletto
Maniglia LAMA Laccato Grigio Nabibia opaco
Top Idealcryl colore Laccato Grigio Nabibia opaco
Mensole Laccato Grigio Nabibia opaco
+ schienale Melaminico Noce Canaletto
Specchiera BASIC Filo lucido

Comp.530

Tonalità neutre e colore sono in perfetta sintonia

Neutral shades and color are in perfect harmony
Les tons neutres et la couleur sont en parfaite harmonie

L85 + 30 P50 H50_ Melaminico Rasato Bianco

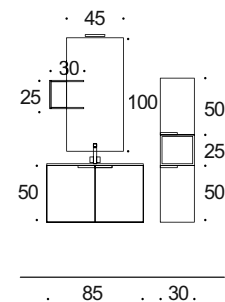

Base lavabo Melaminico Rasato Bianco
Maniglia LAMA Laccato Grigio Ferro opaco
Top ELITE Lucido
Mensola Melaminico Vulcano
Specchiera BASIC telaio Alluminio spazzolato
Lampada Nice Cromo
Pensili Melaminico Vulcano



Base lavabo Laccato Zafferano opaco
 Maniglia LAMA Laccato Zafferano opaco
 Top Idealcryl colore Zafferano opaco
 Mensole CLOCK Laccato Verde Nevada opaco
 Specchiera BASIC telaio Alluminio spazzolato
 Pensile Laccato Verde Nevada opaco

Comp.531

Il bagno colorato sottolinea forme ed elementi

The colorful bathroom emphasizes shapes and elements
 La salle de bain colorée met en valeur les formes et les éléments

L115 P50 H37.5_ Laccato Zafferano opaco

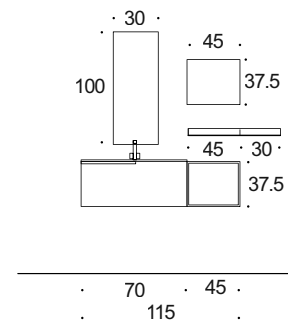



Base lavabo Melaminico Reflex
 Maniglia VELA Laccato Titanio metallizzato
 Top COVERSLIM lucido
 Mensole Laccato Titanio metallizzato
 Specchiera BASIC filo lucido
 Lampada FLY

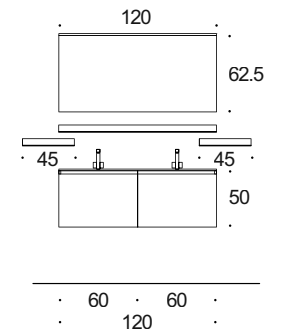

L120 P50 H50_ Melaminico Reflex

Comp.532

**Il fascino di una finitura
 brillante moltiplicato per due**

The charm of a brilliant finish multiplied by two
 Le charme d'une finition brillante multiplié par deux



Comp.533

Un arredo compatto impreziosito dall'effetto marmo

A compact furniture embellished with a marble effect
Un décor compact agrémenté d'un effet marbre

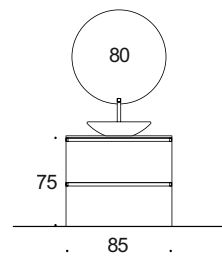

L85 P50 H75_ Melaminico Calacatta



Base lavabo Melaminico Calacatta
Lavabo TONDO FINE lucido
Maniglia VELA Laccato Bianco opaco
Top Melaminico Calacatta
Specchiera ROT con Led

Comp.534

Sensazioni tattili e visive per un bagno ricercato

Tactile and visual sensations for a refined bathroom
Sensations tactiles et visuelles pour une salle de bain raffinée



L90 P50 H87.5_ Melaminico Dogato

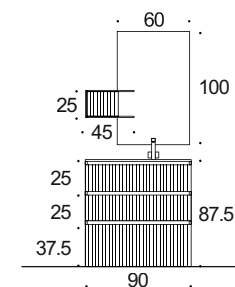

Base lavabo Melaminico Dogato
Maniglia VELA Laccato Piombo opaco
Top Idealcryn Bianco opaco
Mensole Laccato Piombo opaco
+ schienale Melaminico Dogato
Specchiera BASIC con bordo Nero

CONDIZIONI GENERALI DI VENDITA

GENERAL CONDITIONS OF SALE / CONDITIONS GÉNÉRALES DE VENTE

- Il presente listino sostituisce ed annulla tutti i precedenti.
- Le condizioni di vendita che disciplinano i rapporti tra l'acquirente e la Ditta sono quelle previste dal Codice Civile, agli art. 1470 e seguenti.
- In particolare, a deroga e completamento delle disposizioni richiamate, si intendono accettate da ambo le parti le seguenti clausole:
- Ogni ordine è assunto dalla Ditta con riserva di accettazione.
- La fornitura avviene ai prezzi ed alle condizioni vigenti al momento dell'accettazione dell'ordine.
- La Ditta si riserva la facoltà di apportare modifiche ai prezzi, alle condizioni generali di vendita e ai prodotti in qualsiasi momento e senza preavviso.
- Si declina ogni responsabilità relativa ad eventuali inesattezze contenute in questo listino, se dovute a errori di stampa o di trascrizione.
- Si accettano resi solo se espressamente autorizzati e saranno parzialmente o totalmente accreditati al prezzo pagato in rapporto al loro stato di conservazione.
- Le modalità ed i termini di consegna sono a discrezione della Ditta, che si riserva inoltre, di evadere gli ordini in più riprese.
- Le merci viaggiano a rischio e pericolo dell'acquirente anche se vendute franco destino.
- Eventuali reclami o difformità riscontrate tra la fornitura e l'ordine, nonché eventuali vizi o difetti dei prodotti consegnati, devono essere segnalati per iscritto alla Ditta, a mezzo email all'indirizzo servizioclienti@idealbagni.com, entro otto giorni dal ricevimento della merce.
- Le modalità di pagamento ed i relativi termini proposti dall'acquirente dall'ordine devono essere tra quelli previsti dalla Ditta, che, comunque, in ogni caso si riserva di accettarli. L'eventuale accettazione di titoli di credito, in pagamento, da parte della Ditta, avviene sempre salvo buon fine, senza novazione del rapporto e senza modifica del foro competente. Il ritardo del pagamento, anche in una sola rata, dà diritto alla Ditta di chiedere il saldo immediato di tutti i suoi crediti in essere e di risolvere i contratti in corso. Non sono riconosciuti validi pagamenti effettuati ad agenti o produttori salvo particolare autorizzazione scritta. Per quanto previsto vale quanto disposto dagli art. 1498, 1515 e 1519 del C.C.
- Tutte le controversie che dovessero aver origine tra l'acquirente e la Ditta saranno attribuite alla competenza del Foro di Pordenone.
- La fabbricazione di elementi fuori serie è ammessa a discrezione esclusiva della Ditta con una maggiorazione minima del 30%.
- Per ordini con importo netto inferiore a euro 300 per merce verso l'Italia e a euro 500 per merce verso l'estero, verrà applicato un contributo per le spese di trasporto pari a euro 30 per l'Italia e a euro 50 per l'estero.
- Per consegne urgenti di pacchi piccoli verso l'Italia, richieste dal cliente a mezzo di un corriere espresso, verrà addebitato un costo minimo pari a euro 15 (valutato in base al peso e al volume della merce da spedire).

- The conditions of sale which regulate dealings between the purchaser and the Company are those foreseen by article 1470 et seq. of the Civil Code.
- Moreover, the following clauses which deviate from or are complementary to the above mentioned regulations, are considered as being accepted by both parties:
- Each order represents a commitment for the Company with reservation of acceptance.
- Goods are supplied at the price and the conditions which are valid at the time the order is accepted.
- The company reserves the right to modify prices, the general conditions of sale and the products themselves at an time and without prior warning.
- The Company declines all responsibility regarding any eventual inaccuracies contained in this price list due to printing or transcriptions errors.
- Returned goods will be accepted only if expressly authorized and will partially or wholly refunded on the basis of the price paid and theirstate of wear.
- The method and terms of delivery are at the discretion of the Company which, furthermore, reserves the right to clear orders with more than one delivery.
- Goods travel at the risk and hazard of the Purchaser even when sold carriage free.
- The Company must be notified in writing by email to the address: servizioclienti@idealbagni.com, of any complaints of irregularities between the supply and the order, as well as of any eventual imperfections of product defects, within eight days of receiving the goods.
- The method of payment and the conditions proposed by the Purchaser must be amongst those foreseen by the Company by which, however, reserves the right of refusal. In all cases the acceptance by the Company of payment in the form of paper titles is subject to final payment, without novation to the relationship on which they depend and without modifying the place of jurisdiction. Delayed payment, even of a single instalment, gives the Company the right to request the immediate settlement of all outstanding amounts and the rescind the contracts in force. Payments made to agents or manufacturers are not considered valid unless expressly authorize in writing. Such provisions are subject to articles 1498, 1515 and 1519 of the Civil Code.
- All disputes arising between the purchaser and the Company will be settled by the court of Pordenone.
- The manufacture of made-on-measure units is permitted at the sole discretion of the Company with a minimum surcharge of 30%.
- For DAT incoterms shipment, the invoices with a net value of less than 300 euro for Italy and 500 euro for foreign countries will be charged with the transport cost equal to 30 for Italy and 50 euro for foreign countries.

- Le présent tarif remplace et annule tous les précédents.
- Les conditions de vente qui règlent les rapports entre l'acheteur et l'usine sont celles prévues par le code civil italien, art. 1470 et suivants.
- En particulier, malgré que les dispositions citées ont été concordées, il est sous-entendu que les suivantes sont acceptées par les deux parts:
- Chaque commande est acceptée par l'usine qui se réserve le droit d'acceptations.
- La fourniture se fera aux prix et conditions en vigueur au moment de l'acceptation de la commande.
- L'usine décline toute responsabilité relative à éventuelles inexactitudes contenues dans le tarif, due à des erreurs d'édition ou de transcription.
- Les restitutions de marchandise sont acceptées seulement si expressément autorisées et seront partiellement ou totalement crédit aux prix paye en rapport avec leur état de conservation.
- Les modes et les temps de livraison sont à la discrétion de l'usine, qui, entre autre, se réserve le droit d'envoyer les commandes en plusieurs reprises.
- La marchandise voyage aux risques et périls de l'acheteur même si vendue franco de port.
- Réclamations éventuelles ou différences constatées entre la fourniture et la commande ainsi que les imperfections ou défauts éventuels de la marchandise livrée, devront être communiquées par écrit à l'usine par email à l'adresse servizioclienti@idealbagni.com, dans les 8 jours après la réception de la marchandise.
- Le mode de paiement et les termes relatifs proposés par l'acheteur devront être parmi ceux prévus par l'usine, qui en tout cas, se réserve le droit de les accepter. L'acceptation éventuelle par l'usine, de titres de crédit, come paiement, aura lieu si ces derniers sont honores, sans innovation du présent rapport et sans modifica tion du tribunal compétent. Le retard dans le paiement, même d'une seule échéance, donne droit a l'usine de demander le solde immédiat de tous ses crédits et de terminer les articles 1498, 1515 et 1519 du code civil italien dont applicables.
- Tous les litiges, qui pourraient surgir entre l'acheteur et l'usine, seront soumis à la compétence du tribunal de Pordenone.
- La fabrication d'éléments, hors standard, est admise à la discrétion exclusive de l'usine avec une augmentation minimum de 30%.
- Pour facture d'une valeur nette de moins de 300 euro pour l'Italie et 500 euro pour pays étrangers on rajoutera un montant de 30 euro pour l'Italie et de 50 euro pour les pays étrangers pour les frais de transport.

Design & progetto grafico
Internistudio

Foto
Studio Auber

Fotolito e stampa
Grafiche Antiga spa

Stampato
Maggio 2022

Ideal Bagni srl
via Carpené, 10
33070 Maron di Brugnera (Pn) Italy
tel. +39 0434 613031
fax +39 0434 613080

www.idealbagni.com
info@idealbagni.com